

# Optoelectronics Test



# Optoelectronics Test

**2520**

**2520INT**

**System 25**

**Series 2400**

**2502**

**2500INT**

**2510**

**2510-AT**

**8542, 8544,  
8544-TEC**

**7090**

Technical Information .....	318
Selector Guide .....	320
Pulsed Laser Diode Test System .....	321
Integrating Sphere for Pulsed Measurements ..	326
Laser Diode LIVest System .....	329
SourceMeter <sup>®</sup> Instruments .....	332
Dual-Channel Picoammeter for Photodiode Measurements .....	335
Integrating Sphere .....	336
TEC SourceMeter Instrument .....	339
Autotuning TEC SourceMeter Instrument ....	339
Laser Diode Mounts for LIV Test Systems ...	343
Optical Switch Cards .....	344

# Technical Information

## Active optoelectronic device characterization requires more than a current source

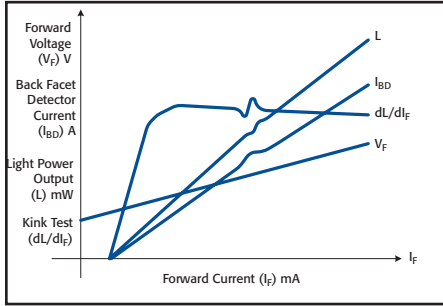

Figure 1. Classic LIV curves associated with semiconductor laser diodes.

Active optoelectronic devices are basic semiconductor junctions. To be fully tested, they require not only forward I-V characterization, but also reverse I-V characterization. While conventional laser diode drivers are valuable for providing drive current in the optics lab, these current sources aren't suitable for developing a complete understanding of a semiconductor device. The SourceMeter® line provides a full range of source and measure capability optimized for semiconductor characterization.

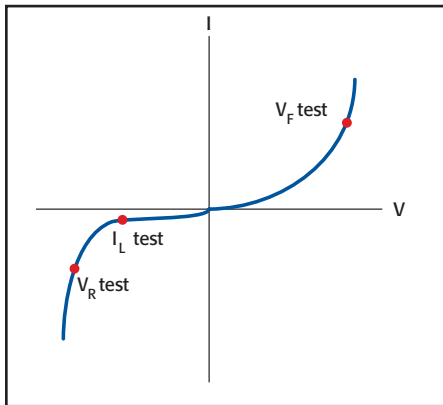

Figure 2. Characterization of semiconductor junctions requires measuring reverse breakdown ( $V_R$ ), leakage current ( $I_L$ ), and forward voltage ( $V_F$ ).

A complete characterization of an active optoelectronic device requires forcing both forward and reverse currents and voltages. For instance, the reverse breakdown test requires sourcing

# Optoelectronics Test

a very small, precise reverse current (10nA) while measuring the voltage. The limited current prevents permanent damage to the device, while allowing a precise breakdown voltage to be measured. Given the breakdown voltage, it's now possible to force a reverse bias that won't harm the device while leakage is measured. This leakage current value is often used to qualify the device for further testing.

## Four-quadrant source capabilities

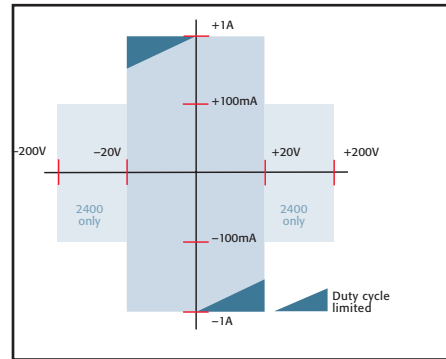

Figure 3. The Model 2400 can source or sink either current or voltage. Other SourceMeter instruments offer different ranges, providing a very wide dynamic range from as low as a  $1\mu\text{A}$  range or 200mV to 5A or 1000V.

The SourceMeter product line combines a full four-quadrant precision source (see Figure 3) with measurement capability. Source and measure ranges provide a very wide dynamic range from as low as a  $1\mu\text{A}$  range or 200mV to 5A or 1000V. These very wide dynamic ranges allow testing diverse devices from delicate AlGaAs laser diodes to silicon avalanche photodiodes.

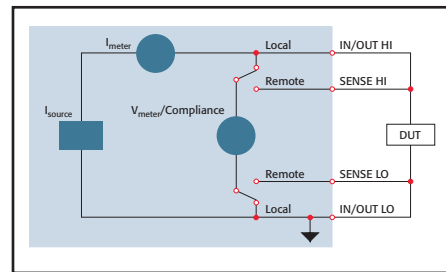

Figure 4. In current source mode, a SourceMeter instrument can force current while measuring voltage. The remote voltage sense ensures the programmable voltage compliance isn't exceeded.

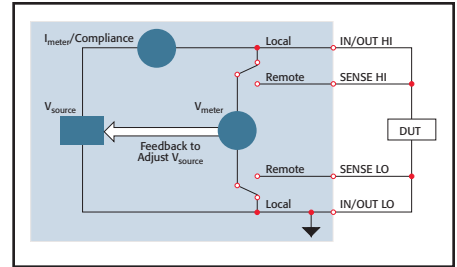

Figure 5. In voltage source mode, a SourceMeter instrument forces a voltage and measures current. Remote sense of the voltage ensures the desired voltage at the DUT.

## Verifying device connections

Series 2400 SourceMeter instruments all offer the Contact Check option, which automatically verifies all test leads are connected to the DUT prior to energizing the test leads or executing a test sequence. Figure 6 shows Contact Check identifying a disconnected remote sense test lead. Without the sense test lead connected, the voltage compliance couldn't be controlled during test execution.

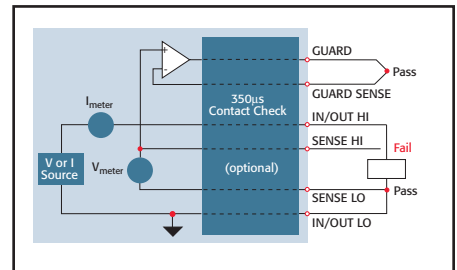

Figure 6. The contact check option verifies the force, sense, and guard test leads are properly connected to the DUT before testing begins.

## Remote voltage measurement

SourceMeter instruments offer two- or four-wire measurement configurations. Two-wire voltage measurement shares test leads with the source as shown in Figure 7a. When sourcing high currents, the voltage drop across the test lead becomes significant with respect to the forward voltage across the DUT.

1.888.KEITHLEY (U.S. only)

www.keithley.com

KEITHLEY

A GREATER MEASURE OF CONFIDENCE

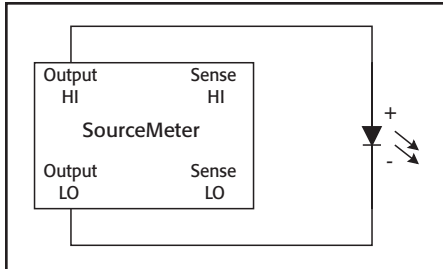

Figure 7a. Two-wire measurement

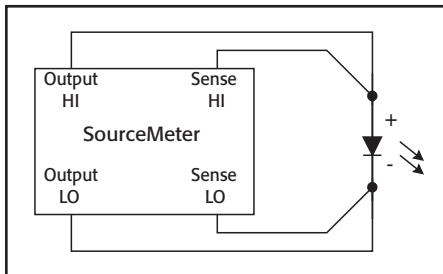

Figure 7b. Four-wire or Kelvin measurement

Four-wire voltage measurement uses dedicated test leads for measuring the voltage drop across the DUT. Since the voltage measurement circuit has very high impedance inputs, the current through the measuring test leads is low. The IR drop across the measurement test leads is an extremely small fraction of the voltage dropped across the DUT.

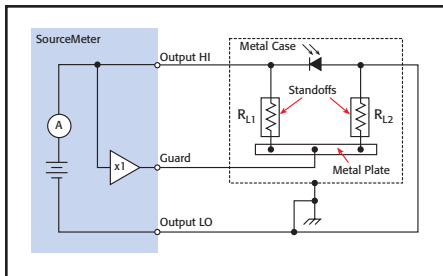

Figure 8. The cable guard circuit drives the guard conductor at the same potential as the output HI conductor.

## Low level current measurements require a driven guard

Unique to precision measurement equipment, the driven guard minimizes the electrical potential difference between the conductors that surround the source test lead and the test lead (see Figure 8). When the electrical potential between the source test lead and guard test lead is low,

the potential leakage paths are neutralized. This technique requires an additional instrumentation amplifier that senses the output of the programmed source and drives the guard circuit with the same potential with enough current to overcome any leakage between the guard components and ground.

## Deterministic trigger I/O

Conventional instruments typically support a simple trigger in/trigger out convention. The challenge to the engineer is controlling the trigger interaction between instruments. It is often that case that simple trigger I/O doesn't allow for differences in instrument behaviors or synchronization of multiple instruments. Figure 9 shows the trigger scheme available on most optoelectronic instrumentation.

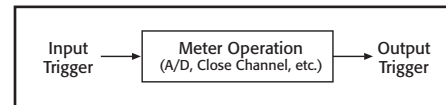

Figure 9. Typical trigger input/output scheme

A Series 2400 instrument breaks the measurement cycle into three parts, as shown in Figure 10. The three components are the source phase, delay phase, and measurement phase (also known as the SDM cycle.) The Series 2400 trigger model allows each phase in the SDM cycle to be programmed so that it can be gated by an input trigger and also to be programmed so that completion of each phase generates an output trigger.

While many instruments are limited to a single trigger in and single trigger out, Series 2400 instruments use a Trigger Link.

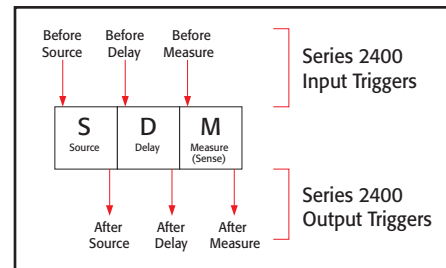

Figure 10. Series 2400 instrument's trigger input/output scheme

Precision characterization of active optoelectronic components often requires multiple instruments working together. For instance, two Series 2400 instruments can be used together: one SourceMeter instrument to drive the device and

another SourceMeter instrument connected to a photodiode to record the optical output of the active device. Figure 11 shows two Series 2400 instruments working synchronously together to characterize an LED.

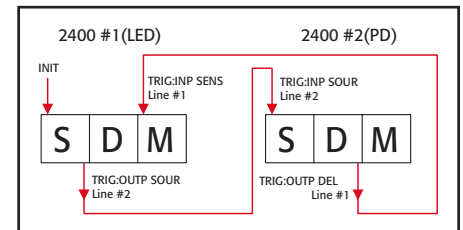

Figure 11. SDM triggers to synchronize two Series 2400 instruments.

Notice how trigger in and trigger out are tied to different parts of the SDM cycle to ensure that measurements on the LED and the PD are made at the same time. This same technique can be applied to ensure that the source current is stable prior to making an optical spectrum measurement with an additional instrument.

## Complete DUT protection

DUT protection is a major concern for optoelectronic devices. SourceMeter instruments are ideal for providing a safe electrical environment for delicate active optoelectronic devices.

- Normal output off mode drives the output terminals toward 0V. This action de-energizes the device and more importantly the inductive test leads. The rate of discharge can be controlled with the source range settings. This provides a better environment than shorting relays in conventional laser diode drivers.
- SourceMeter instruments provide programmable compliance, range compliance, and voltage protection settings to ensure that the DUT isn't subjected to excess voltages or currents.
- Contact check ensures all test leads are in contact with the DUT prior to energizing the device.

In addition, the SourceMeter family is built on a heritage of precision semiconductor test and characterization of much more sensitive devices than active optoelectronic components.

## LIV Test Systems

	2602A	2612A	System 25	2520
Page	10	10	329	321
Max. Drive Current	3 A DC / 10 A pulsed per channel	1.5 A DC / 10 A pulsed per channel	5 A	5 A
Source Mode	DC (Continuous Wave)	Pulse / DC (Continuous Wave)	DC (Continuous Wave)	Pulse / DC (Continuous Wave)
Number of Channels	1 Laser Drive, 1 Photodiode	1 Laser Drive, 1 Photodiode	1 Laser Drive, 2 Photodiode	1 Laser Drive, 2 Photodiode

## Optical Power Measurement

	2502	6487	6485	Photodiode Measurement 2635A/2636A
Page	335	110	107	10

## CURRENT MEASURE

From	15 fA	20 fA	20 fA	120 fA
To	20 mA	20 mA	20 mA	10 A

## PHOTODIODE VOLTAGE BIAS

	100V (each channel)	500 V	none	200 V
--	------------------------	-------	------	-------

## FEATURES

Optical Measurement Head	2500INT Series (Si & Ge) (190nm – 1800nm)	2500INT Series (Si & Ge) (190nm – 1800nm)	2500INT Series (Si & Ge) (190nm – 1800nm)	
Number of Channels	2	1	1	1/2
Instrument Connection	3-slot Triax	3-slot Triax	BNC	3-slot Triax
Communication	GPIB, RS-232	GPIB, RS-232	GPIB, RS-232	GPIB, RS-232, Ethernet (LXI)

## Laser Diode and LED Current Drivers

	2601A	2611A	2401	2420	2440	2520	6220 6221
Page	10	10	332, 33	332, 33	332, 33	321	97

## CURRENT SOURCE

From	5 pA	5 pA	±10 pA	±500 pA	±500 pA	70 μA	80 fA
To	3 A DC / 10 A pulsed per channel	1.5 A DC / 10 A pulsed per channel	±1.05 A	±3 A	±5A	+ 5A	±100 mA
Type	DC/Pulse	DC/Pulse	DC	DC	DC	DC/Pulse	DC/Pulse

## VOLTAGE MEASURE

From	1 μV	1 μV	1 μV	10 μV	10 μV	60 μV	10 nV (w/2182A)
To	40 V	200 V	21 V	60 V	40 V	10 V	100 V (w/2182A)

## FEATURES

Instrument Connection	Screw Terminal	Screw Terminal	Banana	Banana	Banana	10Ω BNC	3-slot Triax
Communication	GPIB/RS-232, TSP, Ethernet (LXI)	GPIB/RS-232, TSP, Ethernet (LXI)	GPIB/RS-232	GPIB/RS-232	GPIB/RS-232	GPIB/RS-232	GPIB/RS-232, Ethernet (6221 only)

1.888.KEITHLEY (U.S. only)

[www.keithley.com](http://www.keithley.com)

**KEITHLEY**

A GREATER MEASURE OF CONFIDENCE

# 2520

## Pulsed Laser Diode Test System

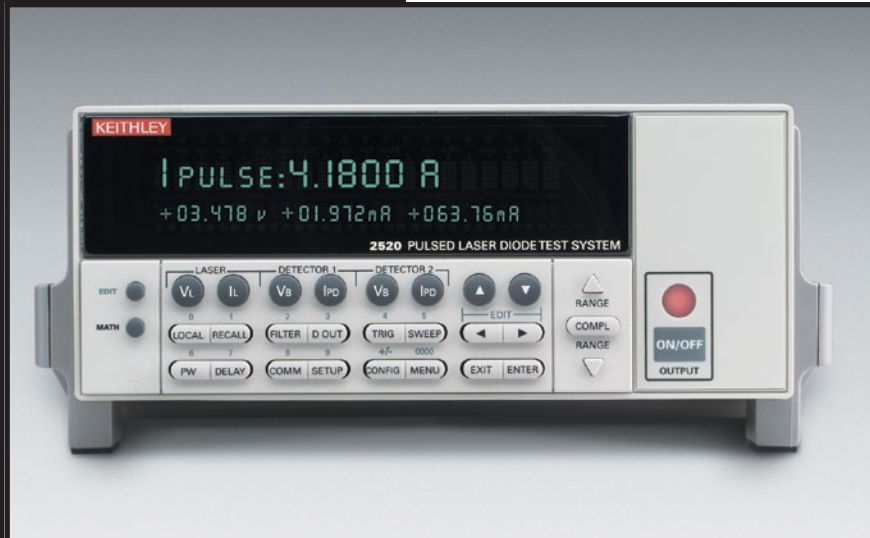

- Simplifies laser diode LIV testing prior to packaging or active temperature control
- Integrated solution for in-process LIV production testing of laser diodes at the chip or bar level
- Sweep can be programmed to stop on optical power limit
- Combines high accuracy source and measure capabilities for pulsed and DC testing
- Synchronized DSP based measurement channels ensure highly accurate light intensity and voltage measurements
- Programmable pulse on time from 500ns to 5ms up to 4% duty cycle
- Pulse capability up to 5A, DC capability up to 1A
- 14-bit measurement accuracy on three measurement channels ( $V_{fr}$  front photodiode, back photodiode)
- Measurement algorithm increases the pulse measurement's signal-to-noise ratio
- Up to 1000-point sweep stored in buffer memory eliminates GPIB traffic during test, increasing throughput
- Digital I/O binning and handling operations
- IEEE-488 and RS-232 interfaces



### Remote Electrical Test Head included

recently, these producers were forced to use relatively slow and cumbersome test stands for testing laser diodes at the chip and bar level, which often led to production bottlenecks.

### Higher Resolution for Higher Yields

To achieve the required signal-to-noise ratio, traditional chip- and bar-level LIV testing solutions have required the use of boxcar averagers or test system control software modifications to allow averaging several pulsed measurements. The resolution of these measurements is critical for the “kink” test and threshold current calculations. With earlier test system designs, particularly when performing the kink test, low resolution and poor linearity of the analog digitizer made it extremely difficult to discriminate between noise in the measurement and an actual device kink. The Model 2520's unique DSP-based measurement approach automatically

The Model 2520 Pulsed Laser Diode Test System is an integrated, synchronized system for testing laser diodes early in the manufacturing process, when proper temperature control cannot be easily achieved. The Model 2520 provides all sourcing and measurement capabilities needed for pulsed and continuous LIV (light-current-voltage) testing of laser diodes in one compact, half-rack instrument. The tight synchronization of source and measure capabilities ensures high measurement accuracy, even when testing with pulse widths as short as 500ns.

### LIV Test Capability

The Model 2520 can perform pulsed LIV testing up to 5A and continuous LIV testing up to 1A. Its pulsed testing capability makes it suitable for testing a broad range of laser diodes, including the pump laser designs for Raman amplifiers. The instrument's ability to perform both DC and pulsed LIV sweeps on the same device simplifies analyzing the impact of thermal transients on the LIV characteristics of the laser diode.

### Maximize Throughput and Eliminate Production Bottlenecks

By working in cooperation with leading laser diode manufacturers, Keithley designed the Model 2520 specifically to enhance chip- and bar-level test stand yield and throughput. Its integrated design, ease of use, high speed, and high accuracy provides a complete solution to help laser diode manufacturers meet their production schedules. Producers of laser diodes face constant pressure to increase test throughput and optimize return on investment for their capital equipment used in production testing. Until

### APPLICATIONS

#### Production testing of:

- Telecommunication laser diodes
- Optical storage read/write head laser diodes
- Vertical Cavity Surface-Emitting Lasers (VCSELs)
- Thermal impedance
- Junction temperature response

1.888.KEITHLEY (U.S. only)

[www.keithley.com](http://www.keithley.com)

KEITHLEY

A GREATER MEASURE OF CONFIDENCE

**2520****Ordering Information****2520 Pulsed Laser Diode Test System with Remote Test Head****2520/KIT1****Pulsed Laser Diode Measurement Kit (includes 2520, 2520INT, and 3 ft. triax cable)****Accessories Supplied****User's Manual, Quick Reference Guide, Triax Cables (2), BNC 10Ω Coaxial Cables (4)****ACCESSORIES AVAILABLE**

2520INT-1-GE	Integrating Sphere (1 inch) with Germanium Detector
7007-1	Double Shielded GPIB Cable, 1m (3.3 ft.)
7007-2	Double Shielded GPIB Cable, 2m (6.6 ft.)
KPCI-488LPA	IEEE-488 Interface/Controller for the PCI Bus
KUSB-488B	IEEE-488 USB-to-GPIB Adapter for USB Port

**SERVICES AVAILABLE**

2520-3Y-EW	1-year factory warranty extended to 3 years from date of shipment
C/2520-3Y-DATA 3 (Z540-1 compliant)	calibrations within 3 years of purchase*

\*Not available in all countries

# Pulsed Laser Diode Test System

identifies the settled region of the pulsed waveforms measured. This means the Model 2520 stores only that portion of the pulse that is "flat" and contains meaningful data. All measurements made in the flat portion of the pulse are averaged to improve the Signal-to-Noise ratio still further. If greater resolution is required, the Model 2520 can be programmed to perform several pulse and measure cycles at the same pulse amplitude. By making it possible to conduct more thorough testing at the bar or chip level, the Model 2520 also eliminates the wasted time and costs associated with assembling then scrapping modules with non-compliant diodes.

**Simple, One-Box Test Solution**

The Model 2520 offers three channels of source and measurement circuitry. All three channels are controlled by a single digital signal processor (DSP), which ensures tight synchronization of the sourcing and measuring functions. The laser diode drive channel provides a current source coupled with voltage measurement capability. Each of the two photodetector channels supplies an adjustable voltage bias and voltage compliance, in addition to current measurement capability. These three channels provide all the source and measure capabilities needed for full LIV characterization of laser diodes prior to integration into temperature controlled modules. By eliminating the need for GPIB commands to perform test sweeps with multiple separate instruments, the Model 2520's integrated sourcing and measurement allows a significant improvement in throughput.

**Remote Test Head Maximizes Signal-to-Noise Ratio**

The mainframe and remote test head architecture of the Model 2520 is designed to enhance pulsed measurement accuracy, even at the sub-microsecond level. The remote test head ensures the measurement circuitry is located near the DUT, mounted on the fixture, minimizing cable effects. As the schematic in **Figure 1** shows, traditional semi-custom systems typically employed in the past require significant integration. The architecture of the Model 2520 (**Figure 2**) offers a far more compact and ready-to-use solution.

**High Speed Pulse and Measure to Minimize Thermal Effects**

The Model 2520 can accurately source and measure pulses as short as 500 nanoseconds to minimize unwanted thermal effects during LIV testing. Users can program the pulse width from 500ns to 5ms and pulse off time from 20μs to 500ms. There is a software duty cycle limit of 4% for currents higher than 1A. To ensure greater accuracy, the instrument provides pulse width programming resolution levels of 10μs (off time) and 100ns (on time).

Prior to the introduction of the Model 2520, test instrument limitations often placed barriers on test performance. However, with the Model 2520, the limiting factor is not the test instrument, but the

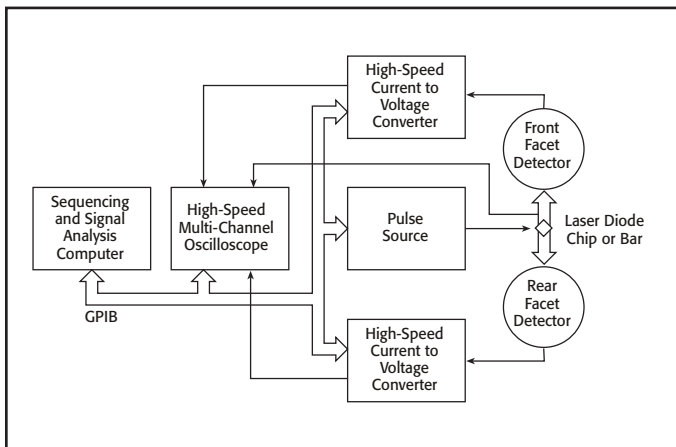

**Figure 1.** This schematic reflects the current testing practices of major laser diode manufacturers. Note that the use of discrete test components increases the integration and programming effort, while severely limiting the flexibility of the test system.

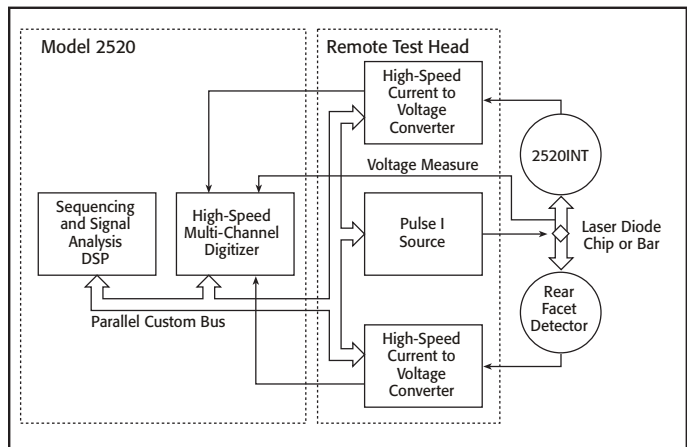

**Figure 2.** The Model 2520 integrates synchronization, source, and measure capabilities in a single half-rack instrument (with remote test head) to provide maximum flexibility and test throughput.

**1.888.KEITHLEY** (U.S. only)**www.keithley.com****KEITHLEY**

A GREATER MEASURE OF CONFIDENCE

physics of the connections to the device. Keithley's optoelectronics applications engineers have addressed these issues by studying and documenting the optimum cable configuration to enhance measurement accuracy with extremely fast pulses. **Figure 3** illustrates the results of a typical pulse LIV sweep test with the Model 2520. In this test, a 100-point pulsed LIV sweep using a  $1\mu\text{s}$  pulse width, at 1% duty cycle, was completed in just 110ms (including data transfer time), several orders of magnitude faster than existing, semi-custom test systems.

### ESD Protection

A laser diode's material make-up, design, and small size make it extremely sensitive to temperature increases and electrostatic discharges (ESDs). To prevent damage, prior to the start of the test and after test completion, the Model 2520 shorts the DUT to prevent transients from destroying the device. The instrument's 500 nanosecond pulse and measure test cycle minimizes device heating during test, especially when a short duty cycle is used.

### Test Sequencing and Optimization

Up to five user-definable test setups can be stored in the Model 2520 for easy recall. The Model 2520's built-in Buffer Memory and Trigger Link interface can reduce or even eliminate time-consuming GPIB traffic during a test sequence. The Buffer Memory can store up to 1000 points of measurement data during the test sweep. The Trigger Link combines six independent software selectable trigger lines on a single connector for simple, direct control over all instruments in a system. This interface allows the Model 2520 to operate autonomously following an input trigger. The Model 2520 can be programmed to output a trigger to a compatible OSA or wavelength meter several nanoseconds prior to outputting a programmed drive current value to initiate spectral measurements.

### Accessories and Options

The Model 2520 comes with all the interconnecting cables required for the main instrument and the remote test head. Production test practices vary widely (automated vs. semi-automated vs. manual), so the cable assemblies from the remote test head to the DUT can vary significantly. To accommodate these differing requirements, Keithley has developed the Model 2520 RTH to DUT Cable Configuration Guide to help customers determine the proper cable assemblies to use to connect the remote test head (RTH) to the DUT.

### Interface Options

The Model 2520 provides standard IEEE-488 and RS-232 interfaces to speed and simplify system integration and control. A built-in digital I/O interface can be used to simplify external handler control and binning operations.

### Additional LIV Test Solutions

For production testing laser diodes after they have been packaged in temperature controlled modules, Keithley offers the Laser Diode LIV Test System with increased 28-bit core measurement resolution, allowing for more detailed characterization. This flexible system combines all the DC measurement capabilities required to test these modules with tight temperature control over the DUT in a modular instrument package. Configured from proven Keithley instrumentation, the basic configuration can be easily modified to add new measurement functions as new testing needs evolve.

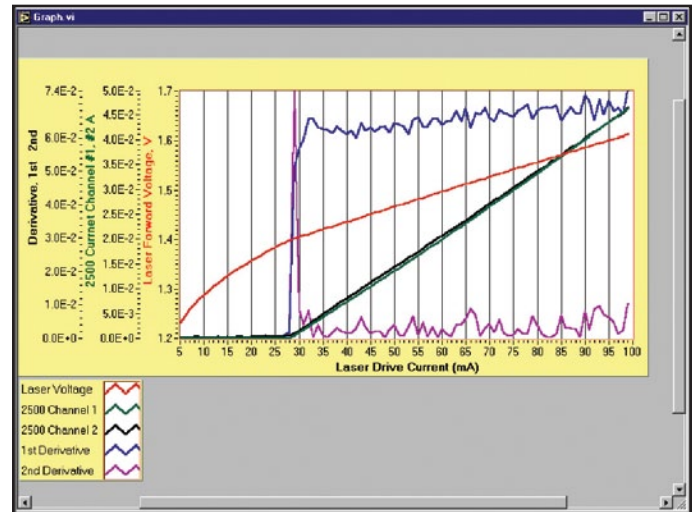

**Figure 3.** This plot illustrates the Model 2520's pulsed LIV sweep capability. The sweep was programmed from 0 to 100mA in 1mA steps. Pulse width was programmed at  $1\mu\text{s}$  at 1% duty cycle, providing for a complete sweep in just 10ms (excluding data transfer time).



**Figure 4.** Model 2520 Remote Test Head



## LASER DIODE PULSE OR DC CURRENT SOURCE SPECIFICATIONS

DRIVE CURRENT					OFF CURRENT <sup>4</sup>			
Source Range	Programming Resolution	Approx. Electrical Resolution	Accuracy <sup>1, 6</sup> ±(%rdg. + mA) <sup>2, 3</sup>	RMS Noise (typical) (1kHz–20MHz)	Range	Programming Resolution	Approx. Electrical Resolution	Accuracy <sup>1</sup> ±(%rdg. + mA)
0–500 mA	10 μA	8 μA	0.2 + 0.45	70 μA	0–15 mA	1 μA	7 nA typ.	0.2 + 0.45
0–1.0 A DC 0–5.0 A Pulse	100 μA	80 μA	0.2 + 4.5	800 μA	0–150 mA	10 μA	70 nA typ.	0.2 + 4.5

TEMPERATURE COEFFICIENT (0°–18°C & 28°–50°C): ±(0.15 × accuracy specification)/°C.

PULSE ON TIME<sup>19</sup>: 500ns to 5ms, 100ns programming resolution.

PULSE OFF TIME<sup>19</sup>: 20μs to 500ms, 10μs programming resolution.

PULSE DUTY CYCLE<sup>19, 20, 21</sup>: 0 to 99.6% for ≤1.0A; 0 to 4% for >1.0A.

VOLTAGE COMPLIANCE: 3V to 10V, 10mV programming resolution<sup>5</sup>.

POLARITY: 1 quadrant source, polarity reversal available through internal relay inversion.

OUTPUT OFF: <200mΩ short across laser diode; measured at Remote Test Head connector.

## LASER DIODE VOLTAGE MEASURE SPECIFICATIONS

Range	Minimum Resolution	Accuracy ±(%rdg. + volts) <sup>1, 12</sup>	RMS Noise (typical) <sup>13</sup>
5.00 V	0.33 mV	0.3% + 6.5 mV	60 μV
10.00 V	0.66 mV	0.3% + 8 mV	120 μV

TEMPERATURE COEFFICIENT (0°–18°C & 28°–50°C): ±(0.15 × accuracy specification)/°C.

MAX. LEAD RESOLUTION: 100Ω for rated accuracy.

INPUT IMPEDANCE: 2MΩ differential, 1MΩ from each input to common.

Input bias current ±7.5μA max.

## PHOTODIODE VOLTAGE BIAS SOURCE SPECIFICATIONS (each channel)

RANGE: 0 to ±20VDC.

PROGRAMMING RESOLUTION: 10mV.

ACCURACY: ±(1% + 50mV).

CURRENT: 160mA max. with V-Bias shorted to I-Measure.

RMS NOISE (1kHz to 5MHz): 1mV typical.

## PHOTODIODE CURRENT MEASURE SPECIFICATIONS (each channel)

Range	Minimum Resolution <sup>4</sup>	DC Input Impedance	Accuracy ±(%rdg. + current) <sup>1, 2</sup>	RMS Noise (typical) <sup>3</sup>
10.00 mA	0.7 μA	< 10 Ω	0.3% + 20 μA	90 nA
20.00 mA	1.4 μA	< 6 Ω	0.3% + 65 μA	180 nA
50.00 mA	3.4 μA	< 3 Ω	0.3% + 90 μA	420 nA
100.00 mA	6.8 μA	<2.5 Ω	0.3% + 175 μA	840 nA

TEMPERATURE COEFFICIENT (0°–18°C & 28°–50°C): ±(0.15 × accuracy specification)/°C.

INPUT PROTECTION: The input is protected against shorting to the associated channel's internal bias supply. The input is protected for shorts to external supplies up to 20V for up to 1 second with no damage, although calibration may be affected.

## SYSTEM SPEEDS

READING RATES (ms)<sup>15, 16</sup>

Number of Source Points <sup>17</sup>	To Memory	To GPIB
1	5.3	6.8
10 <sup>18</sup>	9.5	18
100 <sup>18</sup>	48	120
1000 <sup>18</sup>	431	1170

Setting and Range	Load <sup>7</sup>	Pulse Mode	Pulse Overshoot Max. <sup>6, 8, 9</sup>	Rise/Fall Time <sup>6, 8, 9, 10</sup>	
				Typical	Max.
500 mA	10 Ω ¼ Watt	Fast	1.0%	55 ns	80 ns
500 mA	10 Ω ¼ Watt	Slow	0.1%	1 μs	1.3 μs
5.00 A	1.5 Ω 1 Watt	Fast	1.0%	100 ns	130 ns
5.00 A	1.5 Ω 1 Watt	Slow	0.1%	1 μs	1.3 μs

## GENERAL

DC FLOATING VOLTAGE: User may float common ground up to ±10VDC from chassis ground.

COMMON MODE ISOLATION: >10<sup>9</sup>Ω.

OVERRANGE: 105% of range on all measurements and voltage compliance.

SOURCE OUTPUT MODES:

- Fixed DC Level
- Fixed Pulse Level
- DC Sweep (linear, log, and list)
- Pulse Sweep (linear, log, and list)
- Continuous Pulse (continuous – low jitter)

PROGRAMMABILITY: IEEE-488 (SCPI-1995.0), RS-232, 5 user-definable power-up states plus factory default and \*RST.

DIGITAL INTERFACE:

**Safety Interlock:** External mechanical contact connector and removable key switch.

**Aux. Supply:** +5V @ 300mA supply.

**Digital I/O:** 2 trigger input, 4 TTL/Relay Drive outputs (33V @ 500mA max., diode clamped).

**Trigger Link:** 6 programmable trigger input/outputs.

**Pulse Trigger Out BNC:** +5V, 50Ω output impedance, output trigger corresponding to current source pulse; pulse to trigger delay <100ns. See Figure 3.

MAINS INPUT: 100V to 240V rms, 50–60Hz, 140VA.

EMC: Conforms to European Union Directive 89/336/EEC (EN61326-1).

SAFETY: Conforms to European Union Directive 73/23/EEC (EN61010-1) CAT 1.

VIBRATION: MIL-PRF-28800F Class 3, Random.

WARM-UP: 1 hour to rated accuracy.

DIMENSIONS, WEIGHT:

**Main Chassis, bench configuration (with handle & feet):** 105mm high × 238mm wide × 416mm deep (4½ in. × 9½ in. × 16½ in.), 2.67kg (5.90 lbs).

**Remote Test Head:** 95mm high × 178mm deep (with interlock key installed) × 216mm wide (3½ in. × 7 in. × 8½ in.), 1.23kg (2.70 lbs).

ENVIRONMENT:

**Operating:** 0°–50°C, 70% R.H. up to 35°C. Derate 3% R.H./°C, 35°–50°C.

**Storage:** –25° to 65°C.

1.888.KEITHLEY (U.S. only)

www.keithley.com

KEITHLEY

A GREATER MEASURE OF CONFIDENCE

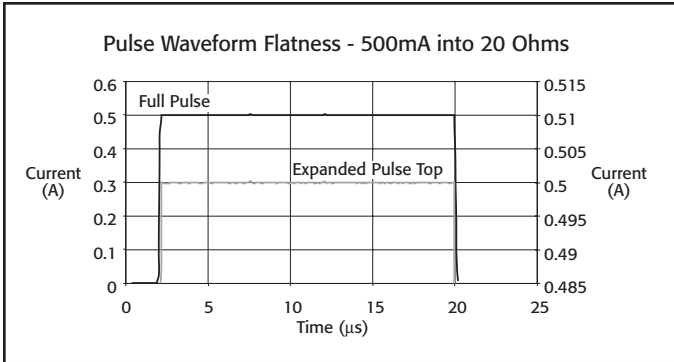

Figure 1

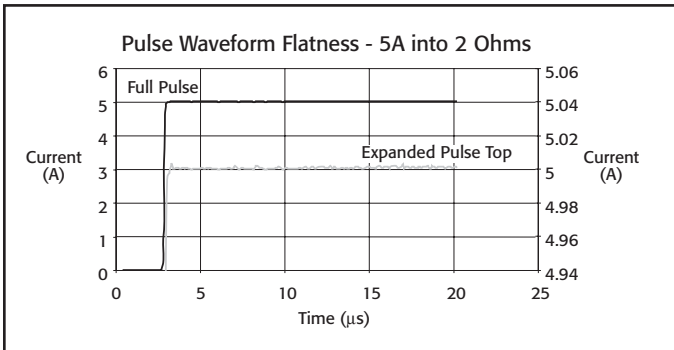

Figure 2

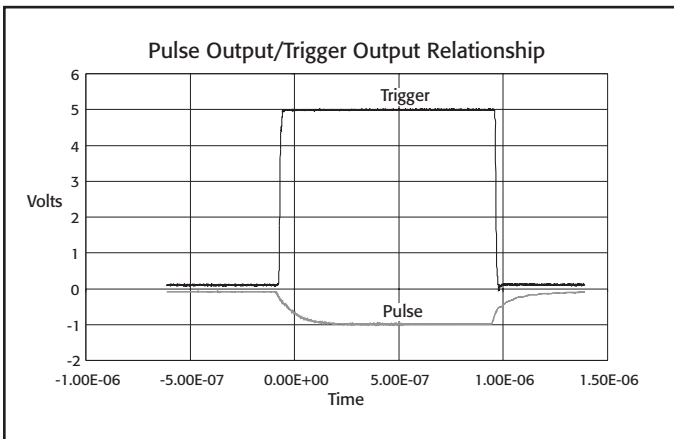

Figure 3

**NOTES**

1. 1 year, 23°C ±5°C.
2. If  $\sqrt{\text{Duty Cycle}} \cdot I$  exceeds 0.2, accuracy specifications must be derated with an additional error term as follows:  
 500mA Range:  $\pm 0.1\% \text{ rdg.} \cdot \sqrt{D} \cdot I$   
 5A Range:  $\pm 0.3\% \text{ rdg.} \cdot \sqrt{D} \cdot I$   
 where:  $I$  = current setting  
 $D$  = duty cycle  
 This derating must also be applied for a period equal to the time that  $\sqrt{D} \cdot I$  was  $\geq 0.2$ .
3. Not including overshoot and setting time.
4. Pulse mode only.
5. Output: 500mA DC on 500mA range and 1A DC on 5A range.
6. Refer to Model 2520 Service Manual for test setup of current accuracy.
7. Figures 1 and 2 are typical pulse outputs into resistive loads.
8. Typical.
9. Per ANSI/IEEE Std 181-1977.
10. Per ANSI/IEEE Std 181-1977 10% to 90%.
11. DC accuracy  $\pm 700\text{mV}$  @ output terminal. 0.2Ω typical output impedance.
12. At DC, 10µs measurement pulse width, filter off.
13. Standard deviation of 10,000 readings with 10µs pulse width, filter off, with I source set to 0A DC.
14. The A/D converter has 14 bit resolution. The useful resolution is improved by reading averaging. The useful resolution is:  

$$\text{Useful Resolution} = \frac{\text{Range}}{2^{14}} \cdot \frac{1}{\sqrt{\frac{\text{Pulse Width (ns)} - 400\text{ns}}{100\text{ns}} \cdot \text{Averaging Filter Setting}}}$$
15. Excluding total programmed (Pulse ON time + Pulse OFF time).
16. Front panel off, calc off, filter off, duty cycle <10%, binary communications.
17. Returning 1 voltage and 2 current measurements for each source point.
18. Sweep mode.
19. Valid for both continuous pulse and sweep modes.
20. Shown is the Power Distribution % based on current settings.
21. Timing Cycle ( $P\%/(pw + pd)$ ): 4% max.

# 2520INT

## Integrating Sphere for Pulsed Measurements

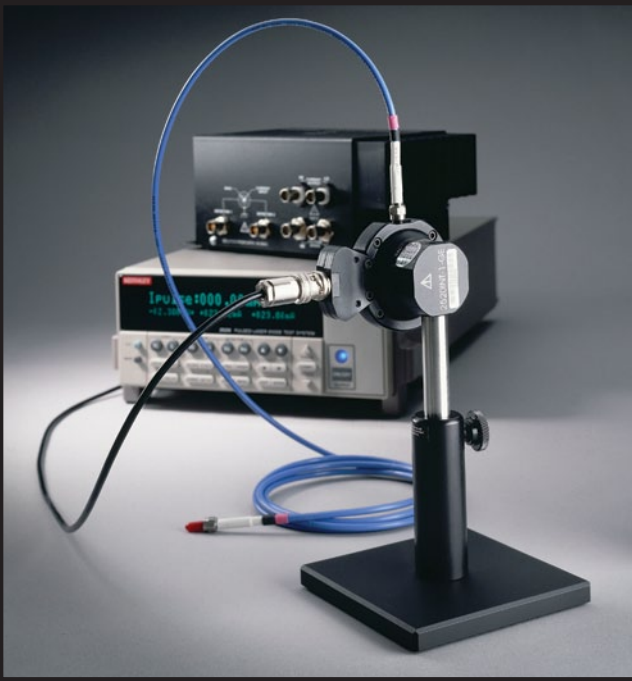

- **Optimized for laser diode pulse testing**
- **Suitable for production and laboratory environments**
- **Built-in germanium detector**
- **Works seamlessly with the Model 2520 Pulsed Laser Diode Test System**

interior is highly reflective Spectralon, which scatters, reflects, and diffuses the source beam the DUT produces. This spreads the light from the DUT uniformly over the sphere's interior surface with minimal absorption loss. The detector, which reads the amount of optical power produced by the DUT, is mounted on the interior surface. Due to the multiple diffuse reflections within the sphere, the amount of optical radiation that strikes the detector is the same as that which falls on any other point on the sphere's interior. To convert the attenuated signal measured by the detector into an accurate optical power measurement, the sphere and detector are calibrated as a unit.

### Simplifies Beam Alignment

In a typical laser diode manufacturing line, the laser diode is not coupled to an optical fiber until the final stages of the packaging process. Therefore, any pulse testing performed on a laser diode at the bar- or chip-level would require a difficult and time-consuming beam alignment process in order to focus all of the diode's output on the optical detector.

To ensure acceptance of the complete beam with maximum divergence angles, the sphere can be located up to 3 millimeters from the DUT, positioned so the diode's light output enters the ¼-inch port on the sphere's side. Any light that enters the sphere is captured in the measurement taken by the Model 2520.

The Model 2520INT Integrating Sphere is designed to optimize the Model 2520 Pulsed Laser Diode Test System's optical power measurement capabilities. It allows the testing of devices with pulse widths as short as 500ns. The short pulses of the Model 2520 combined with the speed of the Model 2520INT make them ideal for measuring the optical power of laser diodes at the bar or chip level, before these devices are integrated into temperature-controlled modules. When connected to the Model 2520 via a low noise triax cable, the Model 2520INT allows the Model 2520 to make direct, high accuracy measurements of a laser diode's optical power. The results are expressed in milliwatts.

### Designed Specifically for Pulsed Laser Diode Testing

Keithley developed the Model 2520INT to address the challenges specific to pulse testing laser diodes, which include short pulse periods and fast rise times. For example, when testing laser diodes in pulse mode, the optical head used must provide a response that's fast enough to measure light pulses as short as 500ns. Many optical power detectors are hampered by long rise times, so they can only measure a portion of the laser diode's light output. Even when using a "fast" detector, many detectors are not good for analog signal measurement. By linking the Model 2520 with the optimum combination of sphere and detector characteristics, Keithley provides the low-level sensitivity needed to ensure accurate pulse measurements.

### Easier Laser Diode Power Measurements

An integrating sphere is inherently insensitive to variations in the beam profile produced by a device under test (DUT). The Model 2520INT's interior is highly reflective Spectralon, which scatters, reflects, and diffuses the source beam the DUT produces. This spreads the light from the DUT uniformly over the sphere's interior surface with minimal absorption loss. The detector, which reads the amount of optical power produced by the DUT, is mounted on the interior surface. Due to the multiple diffuse reflections within the sphere, the amount of optical radiation that strikes the detector is the same as that which falls on any other point on the sphere's interior. To convert the attenuated signal measured by the detector into an accurate optical power measurement, the sphere and detector are calibrated as a unit.

### APPLICATIONS

#### Bar- or chip-level LIV production testing of:

- **980 or 1480 EDFA pump lasers**
- **Raman amplifiers**
- **Telecommunication laser diodes**
- **High power telecommunication VCSELs**

### ACCESSORIES REQUIRED

2520	Pulsed Laser Diode Test System
7078-TRX	Low Noise Triax Cable

1.888.KEITHLEY (U.S. only)

[www.keithley.com](http://www.keithley.com)

**KEITHLEY**

A GREATER MEASURE OF CONFIDENCE

# 2520INT

## Ordering Information

2520INT-1-Ge

1 inch Integrating Sphere with Germanium Detector

2520/KIT1

Pulsed Laser Diode Measurement Package (Includes 2520, 2520INT, and 3-foot triax cable)

## Accessories Supplied

Quick Start Guide, calibration data (supplied as a printed chart and in CSV format on a floppy diskette), base and 1/4-20 post for mounting

# Integrating Sphere for Pulsed Measurements

## Attenuation of Laser Diode Output

Detectors usually have a maximum power limit of a few milliwatts before the detector is over-saturated. The Model 2520INT Integrating Sphere's highly reflective Spectralon interior surface eliminates the problem of detector saturation. This coating reflects and diffuses the light output from the DUT uniformly over the interior surface of the sphere, which inherently attenuates the level of power read by the built-in detector. The power level at any point on the sphere's interior surface is far less than the power level of a beam that falls directly on the detector. This allows testing much higher power devices without risking detector damage. The Model 2520INT's design attenuates the power output of a laser diode by approximately 100:1.

## Optimized for Telecommunications Wavelengths

The Model 2520INT's germanium detector is capable of detecting wavelengths from 800–1700nm. The detector and the sphere are calibrated as a unit in 10nm increments at wavelengths that are of particular interest for laser diode testing (950–1010nm and 1280–1620nm). Calibration constants are provided in printed form as well as in CSV format on a floppy diskette to simplify programming them into a test system. When combined with the Model 2520 Pulsed Laser Diode Test system is capable of measuring power ranging from 14.5mW to 7W, depending on the wavelength (see the specifications for power ranges by wavelengths of interest).

## Fiber Tap for Additional Measurements

The Model 2520INT offers production test engineers the flexibility to decrease overall testing time by supporting multiple optical measurements simultaneously. An additional port on the sphere is compatible with an SMA connector; together, the port and fiber tap can be used to output a fraction of the measured light to an external instrument (such as a spectrometer) via a multimode fiber for additional optical measurements.

## Eliminates Back Reflections

During testing, the stability of a laser diode can be significantly affected by back reflections from objects in the optical path. The geometry of the Model 2520INT and the diffusing properties of its reflective interior help prevent back reflection and ensure greater device stability during testing.

## Production or Laboratory Environments

A slight curvature on the face of the sphere makes Model 2520INT easier to integrate into an automated test system. This curvature allows additional room to connect the sphere to the DUT electrically and simplifies integration with other system components.

The Model 2520INT is designed with four strategically located mounting holes for flexible mounting on laboratory tables or in automated test fixtures. Two of the holes are sized to accommodate metric fixtures, while the other two are designed for use with English fixtures. The Model 2520INT comes with a 1/4-20 base and post.

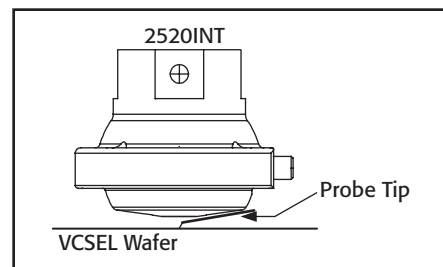

A slight curvature on the face of the sphere allows additional room to connect the DUT electrically in close quarters, such as in wafer probing.

1.888.KEITHLEY (U.S. only)

www.keithley.com

KEITHLEY

A GREATER MEASURE OF CONFIDENCE

# 2520INT

# Integrating Sphere for Pulsed Measurements

## Specifications

FULL ACCEPTANCE ANGLE<sup>1</sup>: 90° vertical, 50° horizontal (max).

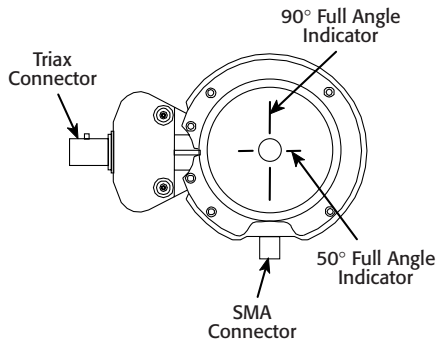

### Frontal View of Integrating Sphere Showing Full Acceptance Angle Indicators

OPERATING WAVELENGTH RANGE: 800–1700nm.

CONTINUOUS WAVE (CW) CALIBRATION WAVELENGTH RANGE<sup>2</sup>: 950–1010nm and 1280–1620nm.

Wavelength (nm)	Measurable Optical Power Range <sup>3</sup>	Typical Responsivity <sup>4</sup> (mA/W)	Resolution <sup>5</sup> (mW)
980	29mW–7W	3.5	0.2
1310	17mW–4W	6.0	0.1
1480	14.5mW–3.5W	7.0	0.1
1550	13.5mW–3W	7.5	0.1

MAXIMUM REVERSE BIAS: 5V (recommended).

DARK CURRENT AT MAX REVERSE BIAS: 4μA (typ); 10μA (max.).

PHOTODIODE ELECTRICAL CONNECTIONS ON 3 LUG TRIAX<sup>6</sup>:

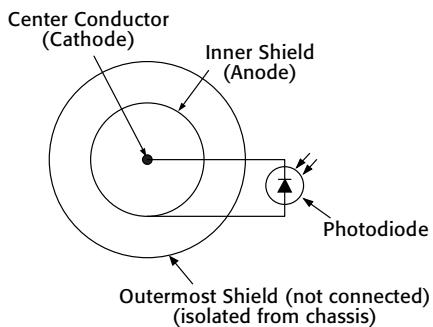

PULSED OPERATION: The 2520INT supports the pulse capabilities of the 2520 Pulsed Laser Diode Test System.

FIBER TAP PORT: Connector Type: SMA. Numerical Aperature (NA): 0.22 (typ.).

Multi-Mode Patch Cord Core Diameter 7 (μm)	Typical Attenuation (dB)
400	39.5
100	53
62.5	58.2
50	63

## GENERAL

INPUT PORT DIAMETER: 0.25 in (6.35mm).

RECOMMENDED CALIBRATION CYCLE: 1 year.

OPERATING TEMPERATURE: 0°–50°C.

STORAGE TEMPERATURE: –25°C–65°C.

DIMENSIONS<sup>8</sup>: 60.0mm long × 86.4mm high × 45.7mm deep (2.36 in × 3.40 in × 1.80 in).

WEIGHT<sup>8</sup>: 0.15kg (0.33 lbs).

## NOTES

- 1 Maximum distance from input port to accept at full maximum acceptance angle: 3.1mm (0.12 in).
- 2 Calibration performed at 10nm wavelength intervals.
- 3 Based on detector being linear to up to 25mA photocurrent and on a signal to noise ratio (SNR) ≥ 100:1.
- 4 Calibration of the 2520INT is performed with an open fiber tap port. The power measurement will increase by approximately 1% with an SMA patch cord attached to the port.
- 5 Based on resolution of Model 2520 at 10mA (lowest) current measurement range.
- 6 This configuration MUST have a NEGATIVE (reverse) bias voltage applied. If a positive (forward) bias is applied, the detector (photodiode) will become damaged.
- 7 Use of single mode fiber is not recommended.
- 8 Only for integrating head, does not include post and base.

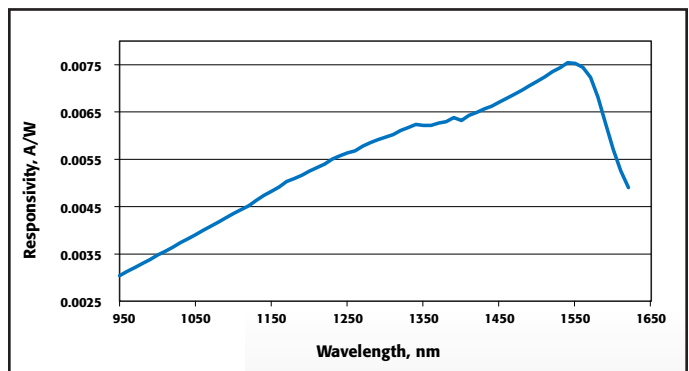

Typical responsivity of the Model 2520INT

# System 25

# Laser Diode Test System Kit



- Programmable LIV test system for laser diode modules
- Sweep and measure 400 points in <8s
- Very low noise current source (50 $\mu$ A) for laser diode drive
- Up to 5A laser diode drive current
- Measures optical power directly
- 1fA resolution for dark current measurements
- Fully digital P-I-D loop for temperature control
- $\pm 0.005^{\circ}\text{C}$  temperature stability,  $\pm 0.001^{\circ}\text{C}$  setpoint resolution
- Trigger Link, source memory, and buffer memory support automatic test sequencing, which greatly reduces GPIB bus traffic to improve test throughput
- Expandable and flexible for future requirements

## Complete DC Test System with Temperature Control

Keithley's LIV (light-current-voltage) Test System Kit is designed to help manufacturers of laser diode modules (LDMs) keep pace with production demands by allowing them to boost yield and throughput. The LIV test system combines all the DC measurement capabilities required to test these modules with optical power measurement and tight temperature control over the device under test in an integrated instrument package. The LIV test system is configured from proven Keithley instrumentation; the basic configuration can be easily modified to add new measurement functions or to allow for new connections.

## Tight Integration Ensures Higher Test Speeds

The LIV test system allows for fast, easy integration and high test speeds because all the building blocks come from the same supplier. All newer Keithley instruments include the Trigger Link feature and digital I/O lines, as well as standard IEEE-488 (GPIB) and RS-232 interfaces, to speed and simplify system integration and control. The Trigger Link feature combines independent software selectable trigger lines on a single connector for simple, direct control over all instruments in a system without the need for constant traffic over the GPIB. This feature is particularly useful for reducing total test time if the test involves a sweep. The digital I/O lines simplify external handler control and binning operations.

Source memory and buffer memory, provided by Models 2400-LV, 2420, 2440, and 2502, enable elimination of GPIB traffic during sweep testing. Source memory is a built-in "programmable test sequencer" for configuring up to 100 different tests. The buffer memory stores data that can be downloaded to the PC via the GPIB after an LIV test sweep is complete. Source memory, buffer memory, and Trigger Link work in concert to form an autonomous test system—all it takes to begin the test sequence is a "start of test" command from the PC. Benchmark testing has demonstrated that these features allow the system to complete a 400-point LIV test sweep with data transfer to the PC in less than eight seconds.

## Easy to Program, Easy to Use

Each kit comes complete with the necessary cables and hardware to use the system. Having all the instrumentation supplied by the same vendor simplifies system programming and improves ease of use. All instruments in the standard system respond to the same SCPI command structure. LabVIEW<sup>®</sup> and Visual Instrument drivers and demonstration software are also available to simplify application development.

## Flexible System Configuration Options

In addition to the standard system configurations, LIV test systems can be customized to accommodate virtually any test sequence or setup requirement. Adding new capabilities or expanding existing ones is as simple as adding a new Keithley instrument or switch system. For example, to add isolation resistance measurements, just include any of Keithley's Series 2000 Digital Multimeters in the configuration.

To accommodate multiple pin-out schemes, choose a Series 7000 Switch Mainframe and plug in one or more switch cards, such as the Model 7012 4 $\times$ 10 Matrix Card or the Model 7053 High Current Scanner Card for switching up to 5A. Automated switching makes it simple to accommodate future pin-out configuration changes.

# System 25

# Laser Diode LIV Test System Kit

A custom configuration and ordering guide is available to simplify selecting all the critical items needed to complete a system.

## Single Vendor Solution

In addition to the assurance of hardware and software compatibility, systems integrators can be confident they'll get all the technical support they need to complete and maintain their systems from a single source. Keithley's applications engineers can help systems integrators optimize the performance of each instrument in the system to ensure high speed and accuracy from the system as a whole.

## High Accuracy Building Blocks

The standard LIV test system provides a fast, flexible solution for testing LDMs by combining the functions of several high speed, high accuracy Keithley instruments:

- **Model 2400-LV, 2420, or 2440 High Current SourceMeter® instrument.** During LIV testing, the SourceMeter instrument provides a current sweep to drive the laser diode. It also synchronizes the measurements made by other instruments in the system. The Models 2400-LV, 2420, and 2440 SourceMeter instruments are part of Keithley's SourceMeter family and were developed specifically for test applications that demand tightly coupled precision voltage and current sourcing and measurement. Selecting the instrument's high current range eliminates the potential for range change glitches if currents higher than 1A are needed during the LIV sweep. The Model 2420 offers drive current of up to 3A. The Model 2440 offers up to 5A of drive current for demanding pump laser control.
- **Model 2502 Dual Photodiode Meter.** The Model 2502 measures the current flow in the back facet photo detector and combines with the Model 2500INT Integrating Sphere to directly measure optical power. Both optical power measurement channels are fully independent. The measurement timing circuitry is shared between both channels to provide simultaneous measurements to optimize LIV performance. Each channel has eight measurement ranges and provides a resolution high enough to measure dark currents of the photodiode. The isolated bias sources provide up to 100V of bias. The Model 2502 has a high speed analog output that allows the LIV system to be combined with a fiber alignment system.
- **Model 2510-AT TEC SourceMeter instrument.** The Model 2510-AT is a 50W bipolar instrument that controls the operation of an LDM's Thermo-Electric Cooler or TEC (sometimes called a "Peltier device") during LIV testing. During testing, the Model 2510-AT measures the internal temperature of the LDM from any of a variety of temperature sensors, then drives power through the TEC in order to maintain the LDM's temperature at the desired setpoint.

The Model 2510-AT's software-based, fully digital P-I-D (proportional-integral-differential) control provides excellent temperature stability. This high stability allows for very fine control over the output wavelength and over the optical power of the LDM during testing. Another Model 2510-AT can be added to include ambient fixture control, if the test will be done under a variety of ambient conditions. The instrument includes a low-level TEC resistance measurement function to check TECs for mechanical damage during module assembly.

The Model 2510-AT offers autotuning capability. P, I, and D (proportional, integral, and derivative) values for closed loop temperature control are determined by the instrument using a modified Zeigler-Nichols algorithm. This eliminates the need for users to experiment by inputting various P, I, and D coefficients repeatedly in order to determine the optimal values.

- **Model 2500INT Integrating Sphere.** This accessory for the Model 2502 accepts direct optical input and provides for accurate L measurement without being sensitive to polarization mode or beam profile at the end of the fiber. The integrating sphere is available with a silicon, germanium, or cooled indium gallium arsenide detector to ensure accurate optical power measurements at any wavelength.
- **Model 854x.** The 854x Laser Diode Mount Series makes it easier than ever to configure a complete laser diode LIV test system for continuous wave test applications. These fixtures provide highly stable temperature control for all telecommunications laser diodes. They offer an easy-to-use platform for testing laser diodes used in telecommunications. They are designed to speed and simplify setting up test systems for all laser diode/photodiode/thermoelectric cooler/thermistor configurations.

For additional information on any of the building blocks of the LIV test system, refer to the data sheet for that instrument.

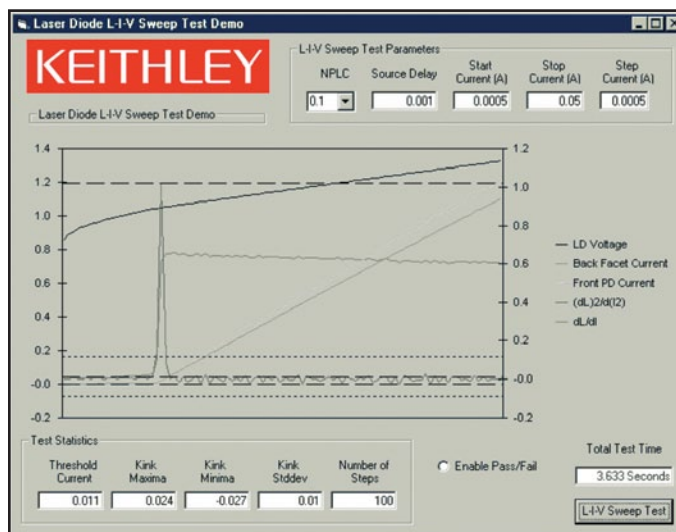

A demonstration software package, written in Visual Basic, is available with the LIV test system to give programmers a head start on creating their own applications. Using the demonstration package, users can set a variety of test parameters, including NPLC (integration time), Source Delay (settling time before measurement), Start Current, Stop Current, and Step Current. These parameters allow users to define the current sweep range and make speed and accuracy trade-offs by adjusting Source Delay and NPLC. The resulting data can be analyzed to determine threshold current and kink statistics. The total test time includes the instrument setup, LIV sweep, and data transfer times (but not the computation times).

1.888.KEITHLEY (U.S. only)

[www.keithley.com](http://www.keithley.com)

KEITHLEY

A GREATER MEASURE OF CONFIDENCE

# System 25

# Laser Diode LIV Test System Kit

## Ordering Information

**S25-**

<b>Source/Measure</b>		
0	2400-LV/2502	General Purpose
2	2420/2502	Transmitter/Pump
4	2440/2502	Pump Laser
<b>Temperature Control</b>		
0	None	
1	2510-AT	Single Temp. Control
2	2510-AT/2510-AT	Dual Temp. Control
<b>Integrating Spheres</b>		
00	None	
21	2500INT-2-SI	2" Sphere, Silicon
22	2500INT-2-GE	2" Sphere, Germanium
23	2500INT-2-IGAC	2" Sphere, Cooled InGaAs
<b>Laser Diode Mounts</b>		
0	None	
2	8542	14-Pin DIL Mount
4	8544	14-Pin Butterfly Mount
4t	8544-TEC	14-Pin Butterfly w/TEC Control

Select the instrument and accessory for your application. Review the detailed specifications of each instrument in individual catalog sections.

### ACCESSORIES INCLUDED IN EACH OPTION

#### SOURCE/MEASURE

Includes: 2400-LV, 2420, or 2440 SourceMeter Instrument  
2502 Photodiode Meter  
(2) GPIB Interface Cables  
Trigger Link Cable  
Integrating Sphere Cable and adapter (Triax, 6172 adapter)  
DUT Cables (terminated in Alligator clips)  
Rackmount Conversion Kit

#### TEMPERATURE CONTROL

Includes: 2510-AT SourceMeter Instrument(s)  
GPIB Interface Cable(s)  
DUT Cables  
Rackmount Conversion Kit

#### INTEGRATING SPHERE

Includes: 2500INT Integrating Sphere  
1/2" open input port  
Post Stand

#### LASER DIODE MOUNT

Includes: 854x Laser Diode Mount  
Easy Connect Multi Terminated Laser Diode Cables  
Easy Connect Multi Terminated Temperature Cables

### CUSTOM SYSTEMS

Custom systems are available. Contact your local Keithley sales person.

### ASSEMBLY SERVICES

The S25 Systems are not assembled. If you would like assembly service, contact your local Keithley salesperson.

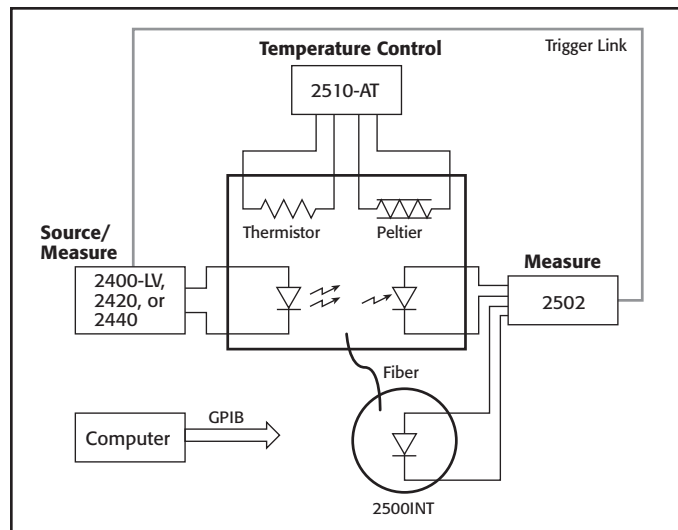

Figure 1. The standard LIV test system is designed for applications that require the highest measurement accuracy. The Model 2420 SourceMeter instrument drives the laser diode, sweeping the drive current from 0A up to 3A in programmable steps. At each step in the sweep, the Model 2420 records the current and voltage measurements, while the Model 2502 measures and records the current flow in the photodiodes. When the sweep is complete, the raw measurement data from the Model 2420 and the Model 2502 is uploaded to the PC for analysis. The LIV Demo Software can calculate first and second derivatives of the back facet monitor diode or the external photo detector.

### ACCESSORIES AVAILABLE

#### CABLES

7007-1 Double Shielded GPIB Cable, 1m (3.3 ft.)  
7007-2 Double Shielded GPIB Cable, 2m (6.6 ft.)

#### FIBER ADAPTERS

(System kit has a 1/2" input port. For fiber input add adapter below.)

2500INT-FC/APC FC/APC Fiber Adapter to Integrating Sphere  
2500INT-FC/PC FC/PC Fiber Adapter to Integrating Sphere  
2500INT-SMA SMA Fiber Adapter to Integrating Sphere

#### CABINETS

(System kit is supplied with all necessary rack mount hardware. Purchase appropriate cabinet and assembly services separately.)

8000-10 Equipment Cabinet 10" high (holds 4 instruments)  
8000-14A Equipment Cabinet 14" high  
8000-17A Equipment Cabinet 17.5" high

#### GPIB CARDS

(GPIB communication required for complete LIV capabilities.)

KPCI-488LPA IEEE-488 Interface/Controller for the PCI Bus  
KUSB-488B IEEE-488 USB-to-GPIB Adapter for USB Port

1.888.KEITHLEY (U.S. only)

www.keithley.com

KEITHLEY

A GREATER MEASURE OF CONFIDENCE



**2400-LV, 2400-C,  
2420, 2420-C,  
2440, 2440-C**

## SourceMeter® Instruments for Optoelectronic I-V Testing



- **Designed for production testing of VCSELs, transmitter, high power pump lasers, and other high current electronic components**
- **Key building block for programmable LIV test system for laser diode modules**
- **Very low noise current source (50µA) for laser diode drive**
- **Up to 5A laser diode drive current**
- **Trigger Link, Source Memory, and buffer memory support automatic test sequencing**
- **Reduced GPIB bus traffic improves test throughput**
- **Expandable and flexible for future requirements**
- **Built-in comparator for fast pass/fail testing**
- **Digital I/O handler interface**
- **1000 readings/second at 4½ digits**
- **Optional contact check function**

The Model 2440 5A SourceMeter Instrument further broadens the capabilities offered by the popular SourceMeter line. The dynamic range and functionality of the Model 2440 makes it ideal for applications such as testing high power pump lasers for use in optical amplifiers, laser bar tests, and testing other higher power components. Manufacturers of Raman pump laser modules and optical amplifiers will find it invaluable for a wide range of design and production test applications.

A Keithley SourceMeter instrument provides a complete, economical, high throughput solution for component production testing, all in one compact, half-rack box. It combines source, measure, and control capabilities in a form factor that's unique to the industry. The SourceMeter is also suitable for making a wide range of low power DC measurements, including resistance at a specified current or voltage, breakdown voltage, leakage current, and insulation resistance.

### Single Box Solution

By linking source and measurement circuitry in a single unit, a SourceMeter instrument offers a variety of advantages over systems configured with separate source and measurement instruments. For example, it minimizes the time required for test station development, setup, and maintenance, while lowering the overall cost of system ownership. It simplifies the test process itself by eliminating many of the complex synchronization and connection issues associated with using multiple instruments. Its compact, half-rack size conserves "real estate" in the test rack or bench.

### ACCESSORIES AVAILABLE

#### LASER DIODE MOUNTS

8542	Dual In-Line Telecom Laser Diode Mount Bundle
8544	Butterfly Telecom Laser Diode Mount Bundle
8544-TEC	Butterfly Telecom Laser Diode Mount Bundle with TEC, thermistor, and AD592CN temperature sensor

#### COMMUNICATION INTERFACE

KPCI-488LPA	IEEE-488 Interface/Controller for the PCI Bus
KUSB-488B	IEEE-488 USB-to-GPIB Adapter for USB Port

#### SWITCHING HARDWARE

7001	Two-Slot Switch System
7002	Ten-Slot Switch System
7053	High-Current Switch Card

#### TEST LEADS AND PROBES

5806	Kelvin Clip Lead Set
------	----------------------

#### CABLES/ADAPTERS

2499-DIGIO	Digital I/O Expansion Assembly
7007-1	Shielded GPIB Cable, 1m (3.3 ft)
7007-2	Shielded GPIB Cable, 2m (6.6 ft)
7009-5	RS-232 Cable
8501-1	Trigger Link Cable, 1m (3.3 ft)
8501-2	Trigger Link Cable, 2m (6.6 ft)
8502	Trigger Link Adapter Box

#### RACK MOUNT KITS

4288-1	Single Fixed Rack Mount Kit
4288-2	Dual Fixed Rack Mount Kit

**1.888.KEITHLEY** (U.S. only)

**www.keithley.com**

**KEITHLEY**

A GREATER MEASURE OF CONFIDENCE

# 2400-LV, 2400-C, 2420, 2420-C, 2440, 2440-C

## Ordering Information

### 2400-LV Low Voltage Model 2400 SourceMeter

Measurements up to 20V and 1A, 20W  
Power Output

### 2400-C General-Purpose SourceMeter

Contact Check, Measurements up to  
200V and 1A, 20W Power Output

### 2420 High-Current SourceMeter

Measurements up to 60V and 3A, 60W  
Power Output

### 2420-C High-Current SourceMeter

Contact Check, Measurements up to 60V  
and 3A, 60W Power Output

### 2440 5A SourceMeter

Measurements up to 40V and 5A, 50W  
Power Output

### 2440-C 5A SourceMeter

Contact Check, Measurements up to 40V  
and 5A, 50W Power Output

## Accessories Supplied

Test Leads, User's Manual, Service  
Manual, and LabVIEW® Drivers

# SourceMeter® Instruments for Optoelectronic I-V Testing

## High Throughput to Meet Demanding Production Test Schedules

A SourceMeter instrument's highly integrated architecture offers significant throughput advantages. Many features of this family enable them to "take control" of the test process, eliminating additional system bus traffic and maximizing total throughput. Built-in features that make this possible include:

- Source Memory List test sequencer with conditional branching
- Handler/prober interface
- Trigger Link compatibility with switching hardware and other instruments from Keithley
- High speed comparator, pass/fail limits, mathematical scaling
- Deep memory buffer

The SourceMeter instruments also offer standard RS-232 and GPIB interfaces for integration with a PC. Adding one of Keithley's versatile switch systems enables fast, synchronized multipoint testing.

## Testing Optoelectronic Components

Use a SourceMeter instrument to measure a component's electrical performance characteristics and to drive laser diodes and other components.

### Types of Optoelectronic Components

- Laser diodes
- Laser diode modules
- Photodetectors
- Light-emitting diodes (LEDs)
- Photovoltaic cells

### Typical Tests

- LIV test (laser diodes and LEDs)
- Kink test (laser diode)
- I-V characterization

Model	2400-LV/2400-C	2420/2420-C	2440-LV/2440-C
Description	General Purpose	3 A	5 A
Power Output	20 W	60 W	50 W
Voltage Range	$\pm 1 \mu\text{V}$ to $\pm 20 \text{ V}$	$\pm 1 \mu\text{V}$ to $\pm 63 \text{ V}$	$\pm 1 \mu\text{V}$ to $\pm 42 \text{ V}$
Current Range	$\pm 50 \text{ pA}$ to $\pm 1.05 \text{ A}$	$\pm 500 \text{ pA}$ to $\pm 3.15 \text{ A}$	$\pm 500 \text{ pA}$ to $\pm 5.25 \text{ A}$
Ohms Range	$< 0.2 \Omega$ to $> 200 \Omega$	$< 0.2 \Omega$ to $> 200 \text{ M}\Omega$	$< 2.0 \Omega$ to $> 200 \text{ M}\Omega$
Applications	Optoelectronic components. VCSELs.	Transmitter modules. EDFA pumps.	5A pump laser diodes. Raman amplifiers.

Model 2400-LV  
SourceMeter  
Instrument

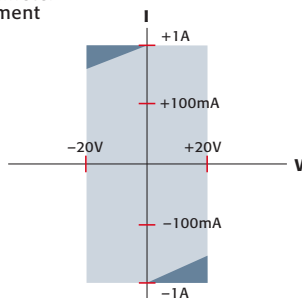

The Model 2400-LV is ideal for testing a wide variety of devices, including diodes, resistors, resistor networks, active circuit protection devices, and portable battery-powered devices and components.

Model 2420  
3A SourceMeter  
Instrument

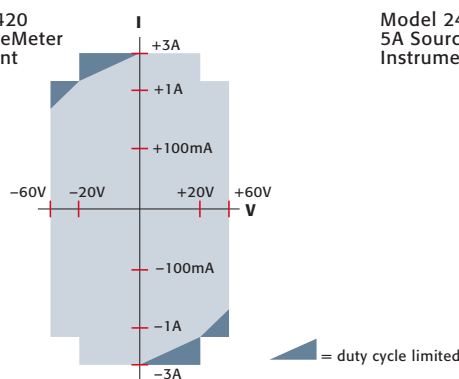

Choose the Model 2420 for testing higher power resistors, thermistors,  $I_{DDQ}$ , solar cells, batteries, and high-current or medium power diodes, including switching and Schottky diodes.

Model 2440  
5A SourceMeter  
Instrument

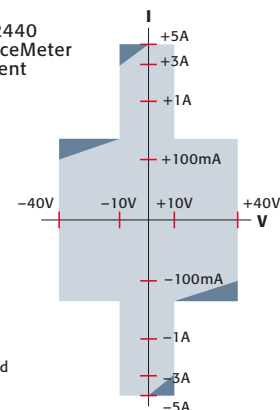

The Model 2440's wide dynamic range is well-suited for applications such as testing high-power pump lasers for use in optical amplifiers and laser bar tests, as well as testing other higher power components.

1.888.KEITHLEY (U.S. only)

[www.keithley.com](http://www.keithley.com)

**KEITHLEY**

A GREATER MEASURE OF CONFIDENCE

# 2400-LV, 2400-C, 2420, 2420-C, 2440, 2440-C

# SourceMeter® Instruments for Optoelectronic I-V Testing

## Faster, Easier, and More Efficient Testing and Automation

### Coupled Source and Measure Capabilities

The tightly coupled nature of a SourceMeter instrument provides many advantages over separate instruments. The ability to fit a source and a meter in a single half-rack enclosure saves valuable rack space and simplifies the remote programming interface. Also, the tight control and a single GPIB address inherent in a single instrument result in faster test times for ATE applications due to reduced GPIB traffic.

### Standard and Custom Sweeps

SourceMeter instruments provide sweep solutions that greatly accelerate testing with automation hooks for additional throughput improvement.

## Optional Contact Check

The Contact Check option available on all Series 2400 SourceMeter instruments allows quick verification of a good connection to the DUT before functional testing proceeds. This feature helps prevent the loss of precious test time due to damaged, corroded, or otherwise faulty contacts in a test fixture. The innovative contact check design completes the verification and notification process in less than 350µs; comparable capabilities in other test equipment can require up to 5ms to perform the same function. Contact check failure is indicated on the instrument's front panel and over the GPIB bus. The digital I/O interface can also be used to communicate contact failure to the component handler in automated applications.

## SOURCEMETER INSTRUMENT SPECIFICATIONS

The following tables summarize the capabilities of the Models 2400-LV, 2420, and 2440.

### 2400-LV SOURCEMETER (I-V MEASUREMENTS)

#### Current Programming Accuracy

Range	Programming Resolution	Accuracy (1 Year) 23°C ± 5°C ± (% rdg. + amps)
1.00000 µA	50 pA	0.035% + 600 pA
10.0000 µA	500 pA	0.033% + 2 nA
100.000 µA	5 nA	0.031% + 20 nA
1.00000 mA	50 nA	0.034% + 200 nA
10.0000 mA	500 nA	0.045% + 2 µA
100.000 mA	5 µA	0.066% + 20 µA
1.00000 A	50 µA	0.27 % + 900 µA

#### Voltage Measurement Accuracy

Range	Default Resolution	Input Resistance	Accuracy (1 Year) 23°C ± 5°C ± (% rdg. + volts)
200.000 mV	1 µV	> 10 GΩ	0.01 % + 300 µV
2.00000 V	10 µV	> 10 GΩ	0.012% + 300 µV
20.0000 V	100 µV	> 10 GΩ	0.015% + 1.5 mV

### 2420 SOURCEMETER (I-V MEASUREMENTS)

#### Current Programming Accuracy

Range	Programming Resolution	Accuracy (1 Year) 23°C ± 5°C ± (% rdg. + amps)
10.0000 µA	500 pA	0.033% + 2 nA
100.000 µA	5 nA	0.031% + 20 nA
1.00000 mA	50 nA	0.034% + 200 nA
10.0000 mA	500 nA	0.045% + 2 µA
100.000 mA	5 µA	0.066% + 20 µA
1.00000 A	50 µA	0.067% + 900 µA
3.00000 A	50 µA	0.059% + 2.7 mA

#### Voltage Measurement Accuracy

Range	Default Resolution	Input Resistance	Accuracy (1 Year) 23°C ± 5°C ± (% rdg. + volts)
200.000 mV	1 µV	> 10 GΩ	0.012% + 300 µV
2.00000 V	10 µV	> 10 GΩ	0.012% + 300 µV
20.0000 V	100 µV	> 10 GΩ	0.015% + 1 mV
60.0000 V	1 mV	> 10 GΩ	0.015% + 3 mV

### 2440 SOURCEMETER (I-V MEASUREMENTS)

#### Current Programming Accuracy

Range	Programming Resolution	Accuracy (1 Year) <sup>3</sup> 23°C ± 5°C ± (% rdg. + amps)
10.0000 µA	500 pA	0.033% + 2 nA
100.000 µA	5 nA	0.031% + 20 nA
1.00000 mA	50 nA	0.034% + 200 nA
10.0000 mA	500 nA	0.045% + 2 µA
100.000 mA	5 µA	0.066% + 20 µA
1.00000 A	50 µA	0.067% + 900 µA
5.00000 A	50 µA	0.10 % + 5.4 mA

#### Voltage Measurement Accuracy

Range	Default Resolution	Input Resistance	Accuracy (1 Year) 23°C ± 5°C ± (% rdg. + volts)
200.000 mV	1 µV	> 10 GΩ	0.012% + 300 µV
2.00000 V	10 µV	> 10 GΩ	0.012% + 300 µV
10.0000 V	100 µV	> 10 GΩ	0.015% + 750 µV
40.0000 V	1 mV	> 10 GΩ	0.015% + 3 mV

1.888.KEITHLEY (U.S. only)

[www.keithley.com](http://www.keithley.com)

**KEITHLEY**

A GREATER MEASURE OF CONFIDENCE

# 2502

## Dual-Channel Picoammeter for Photodiode Measurements



- Dual-channel instrument for low current measurements
- $\pm 100\text{V}$  bias source
- Measure current from 1fA to 20mA
- 1fA current measurement resolution
- 0–10V analog output for high resolution optical power feedback
- 3000-point buffer memory on each channel allows data transfer after test completion
- Digital I/O and Trigger Link for binning and sweep test operations
- IEEE-488 and RS-232 interfaces

### Ordering Information

2502 Dual-Channel Picoammeter

Accessories Supplied  
User's Manual

The Model 2502 combines Keithley's expertise in low-level current measurements with high speed current measurement capabilities. Each channel of this instrument consists of a voltage source paired with a high speed picoammeter. Each of the two channels has an independent picoammeter and voltage source with measurements made simultaneously across both channels.

### Wide Dynamic Measurement Range

The Model 2502 offers current measurement ranges from 2nA to 20mA in decade steps. This provides for all photodetector current measurement ranges for testing laser diodes and LEDs in applications such as LIV testing, LED total radiance measurements, measurements of cross-talk and insertion loss on optical switches, and many others. The Model 2502 meets industry testing requirements for the transmitter as well as pump laser modules.

### High Accuracy Dark Current Measurements

The Model 2502's 2nA current measurement range is ideal for measuring dark currents with 1fA resolution. Once the level of dark current has been determined, the instrument's REL function automatically subtracts the dark current as an offset so the measured values are more accurate for optical power measurements.

### Voltage Bias Capability

The Model 2502 provides a choice of voltage bias ranges:  $\pm 10\text{V}$  or  $\pm 100\text{V}$ . This choice gives the system integrator the ability to match the bias range more closely to the type of photodetector being tested, typically  $\pm 10\text{V}$  for large area photodetectors and  $\pm 100\text{V}$  for avalanche-type photodetectors. This ability to match the bias to the photodetector ensures improved measurement linearity and accuracy.

### Ratio and Delta Measurements

The Model 2502 can provide ratio or delta measurements between the two completely isolated channels, such as the ratio of the back facet monitor detector to the fiber-coupled photodetector at varying levels of input current. These functions can be accessed via the front panel or the GPIB interface. For test setups with multiple detectors, this capability allows for targeted control capabilities for the laser diode module.

### Interface Options

To speed and simplify system integration and control, the Model 2502 includes the Trigger Link feature and digital I/O lines, as well as standard IEEE-488 and RS-232 interfaces. The Trigger Link feature combines six independent software selectable trigger lines on a single connector for simple, direct control over all instruments in a system. This feature is especially useful for reducing total test time if the test involves a sweep. The Model 2502 can sweep through a series of measurements based on triggers received from the SourceMeter Instrument. The digital I/O lines simplify external handler control and binning operations.

For additional information and detailed specifications, see page 114.



Model 2502 rear panel

Dual-channel optical power measurement

OPTOELECTRONICS TEST

1.888.KEITHLEY (U.S. only)

www.keithley.com

KEITHLEY

A GREATER MEASURE OF CONFIDENCE

# 2500INT

## Integrating Sphere

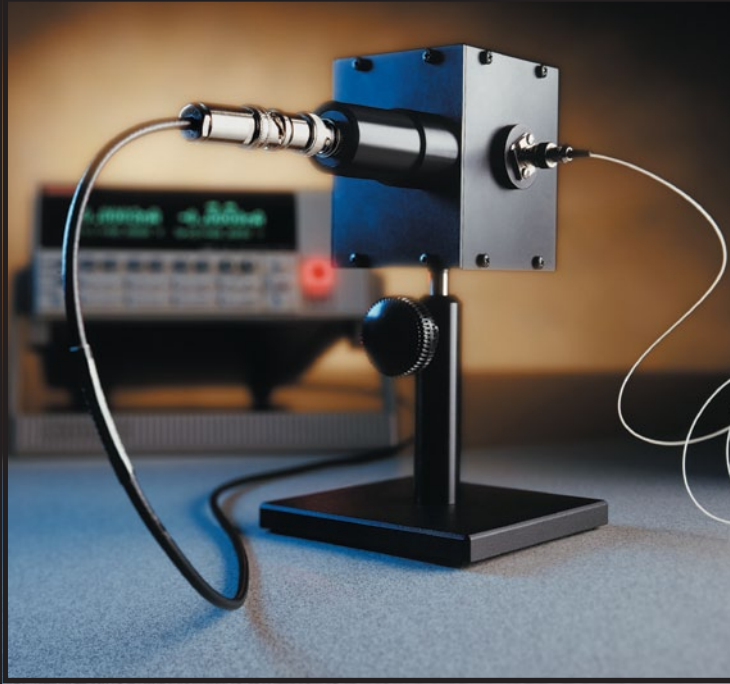

- Choose from silicon, germanium, or cooled indium gallium arsenide detectors
- Spectralon® sphere interior ensures high reflectivity
- Part of Keithley's high throughput system for production testing of laser diodes and LEDs

### Ordering Information

**2500INT-2-Si**Integrating Sphere  
with Silicon Detector**2500INT-2-Ge**Integrating Sphere with  
Germanium Detector**2500INT-2-IGAC**Integrating Sphere with  
Cooled Indium Gallium  
Arsenide Detector**Accessories Supplied**Quick Start Guide, Calibration  
Chart for each sphere,  
TEC Controller (included with  
2500INT-2-IGAC)

The Model 2500INT Integrating Sphere is the latest addition to Keithley's growing line of solutions for LIV (light-current-voltage) testing. When connected via a low noise triax cable to the Model 2502 Dual Photodiode Meter included in Keithley's LIV Test System, the integrating sphere allows the system to make direct measurements of optical power, with results expressed in watts. The integrating sphere simplifies production testing of laser diodes (LDs), light emitting diodes (LEDs), and other optical components by eliminating common optical power measurement problems related to detector alignment, beam profile, polarization, and back reflection.

### Choice of Three Detector Types

The Model 2500INT is available with a silicon (2500INT-2-Si), germanium (2500INT-2-Ge), or cooled indium gallium arsenide (InGaAs) detector (2500INT-2-IGAC), each calibrated with the sphere. Spheres equipped with cooled indium gallium arsenide detectors include a controller to regulate the detector's temperature.

### Unaffected by DUT Beam Profile

Laser diodes can produce non-gaussian beam profiles, which can lead to inaccurate optical power measurements due to underfill or overfill of the detector. While a number of methods are available to correct for underfill and overfill, these methods can add to the overall inaccuracy of the measurement.

In contrast, an integrating sphere is inherently insensitive to beam profiles. The interior of the Model 2500INT integrating sphere has a highly reflective Spectralon surface, which scatters, reflects, and diffuses the source beam produced by the device under test (DUT). This spreads the light from the DUT uniformly over the interior surface of the sphere with minimal absorption loss. A detector can be placed on the interior surface of the sphere, then the sphere/detector combination can be calibrated. The amount of optical radiation striking the detector is the same as any other point on the sphere interior due to the multiple diffuse reflections within the sphere. Therefore, the calibration and resulting measurement accuracy are independent of beam profile.

The Model 2500INT's Spectralon surface offers a variety of other advantages. It is a nearly perfect diffuse reflector, exhibiting Lambertian reflectance properties, so it reflects equally in all directions, regardless of viewing angle. This eliminates the inaccuracies associated with less diffuse materials by distributing the optical radiation more evenly over the interior of the sphere. In addition, a Spectralon surface offers high reflectance for wavelengths from 250–2500nm, which makes it ideal for laser diode measurement applications. It is also chemically inert, which helps ensure stable measurements in harsh environments.

### Eases Beam Alignment

If an integrating sphere is not used in laser diode testing, the entire beam from the laser must shine directly onto the detector in order to measure optical power accurately. However, it is difficult to align a laser and detector with the high degree of precision required, particularly when the laser is operating outside of the visible spectrum. With the use of an integrating sphere, beam alignment is trivial because any light that enters the sphere will be spread evenly across its interior surface. Simply stated, it is easier to direct a laser into a 1/2-inch port than it is to direct a laser onto a 5mm detector. The sphere

### APPLICATIONS

**Production testing of:**

- Laser diode modules
- Chip on submount laser diodes
- Laser diode bars
- LEDs
- Passive optical components

**1.888.KEITHLEY** (U.S. only)**www.keithley.com****KEITHLEY**

A GREATER MEASURE OF CONFIDENCE

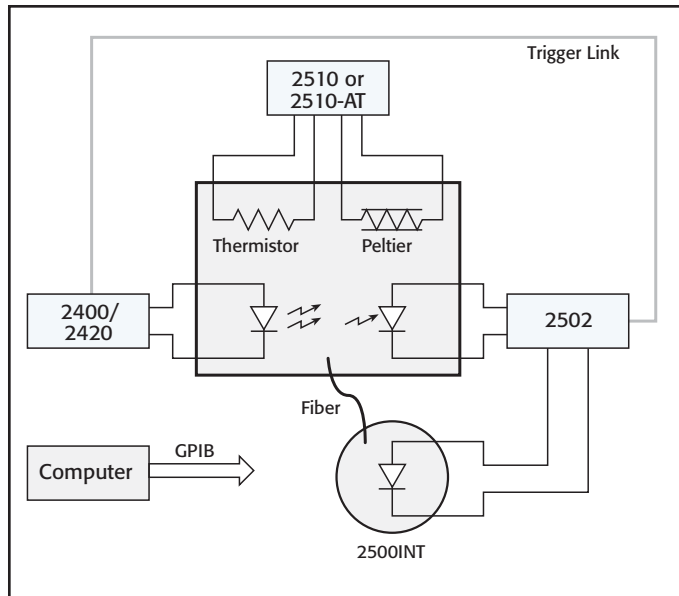

The Model 2500INT allows the LIV Test System to measure optical inputs directly and to display power measurements in watts. Other instruments in the LIV Test System include the Model 2502 Dual Photodiode Meter, the Model 2510 TEC SourceMeter® Instrument, and either the Model 2400 or Model 2420 SourceMeter Instrument. Each integrating sphere is characterized at the factory and provided with a calibration constant for every 25 nanometers in the detector's range. Prior to testing, the user simply enters the constant in the Model 2502 Dual Photodiode Meter to ensure accurate measurements of optical power for that wavelength.

is insensitive to input beam alignment up to 40° off normal or divergences up to 40° half-angle.

### Minimizes Polarization Concerns

The randomizing effects of multiple reflections within Keithley's integrating sphere minimize beam polarization problems that can affect optical measurement accuracy when measuring polarized sources. Beam polarization is of particular concern for manufacturers of distributed feedback lasers (DFBs) and Vertical Cavity Surface Emitting Lasers (VCSELs).

### Eliminates Back Reflection

The stability of a laser diode is significantly affected by back reflections from objects in the optical path. The geometric nature of the integrating sphere and the diffusing properties of the sphere's reflective material help prevent back reflection and ensure greater device stability during testing.

### Attenuates High Power Laser Diode Outputs

Detectors have specified maximum power capability, which is typically just a few milliwatts. By spreading the output power evenly over its interior surface, an integrating sphere automatically attenuates the power from the source; therefore, the power level at any point on the sphere surface is far less than that of a beam that falls directly on the detector. The Model 2500INT sphere is particularly useful for testing high-power laser diodes because it provides calibrated attenuation of the laser diode output, which prevents damage to the detector due to the high density of the output or other problems associated with saturation of the detector.

### Designed Specifically for Laser Diode Testing

The design of the Model 2500INT Integrating Sphere is optimized for measuring the optical power of laser diodes. Each sphere is two inches in diameter with a 1/2-inch input port suitable for fiber or direct light (as in chip on submount applications). The port and detector are positioned so there is no need to use a baffle to prevent the input from shining directly onto the detector.

	Silicon Detector	Germanium Detector	Cooled InGaAs Detector
Wavelength Range	190–1100 nm	800–1800 nm	900–1670 nm
Peak Wavelength ( $\lambda_p$ )	960 nm	1550 nm	1550 nm
Sensitivity at Peak Wavelength	Excellent at 960 nm	Good at 1550 nm	Excellent at 1550 nm
Sensitivity at Certain Wavelengths			
Visible	***	N/A	N/A
980 nm	***	**	**
1310 nm	N/A	**	***
1550 nm	N/A	**	***
>1550 nm	N/A	**	***
Speed	***	*	**
Calibration Accuracy/Stability	Spectral response changes rapidly with temperature at wavelengths >1000nm.	Spectral response changes rapidly with temperature and $\lambda$ above $\lambda_p$ .	Extremely stable (Spectral response is stable because $\lambda$ calibration is fixed at constant operating temperatures, i.e., -10°C.)
Cost	\$	\$\$	\$\$\$

\* = Good    \*\* = Better    \*\*\* = Best    N/A = not applicable

### Detector Selection Criteria

When choosing the most appropriate detector for a specific application, consider the following selection criteria:

- Wavelengths of maximum interest
- Sensitivity at wavelength of interest
- Speed
- Cost
- Calibration accuracy/stability

## SPECIFICATIONS

### TYPICAL REFLECTANCE DATA FOR SPECTRALON MATERIAL

Wavelength (nm)	Spectralon
500	0.991
600	0.992
700	0.992
800	0.991
900	0.992
1000	0.993
1100	0.992
1200	0.992
1300	0.992
1400	0.991
1500	0.990
1600	0.989
1700	0.986

1800	0.987
------	-------

### PHYSICAL, THERMO-OPTICAL, AND ELECTRONIC PROPERTIES OF SPECTRALON MATERIAL

Property	ASTM Test	Value
Density	N/A	1.25–1.5g/cm <sup>3</sup>
Water Permeability	D-570	<0.001% (hydrophobic)
Hardness	D-785	20–30 Shore D
Thermal Stability	N/A	Decomposes at >400°C
Coefficient of Linear Expansion	D-696	5.5–6.5 × 10 <sup>-5</sup> in/in -°F; 10 <sup>-4</sup> °C <sup>-1</sup>
Vacuum Stability	N/A	No outgassing except for entrained air
Flammability	N/A	Non-flammable (UL rating V-O) Incompatible with non-polar solvents and greases
Yield Stress	D-638	208psi
Ultimate Stress	D-638	891psi
Young's Modulus	N/A	35774psi
Elongation in 2 in.	D-638	42.8%
Elongation at Failure	E-132	91.3%
Poisson's Ratio	D-621	0.296
Deformation under Load	D-621	13.3% @ 250 lbs. 22.6% @ 500 lbs.
Absorbance (ax)	N/A	0.07
Emittance (e)	N/A	0.88
Volume Resistivity	N/A	>10 <sup>18</sup> Ω/cm
Dielectric Strength	D-149	18V/μm
Refractive Index	D-542	1.35
Flammability Rating	UL-94	V-O

### ACCESSORIES AVAILABLE

(Appropriate cables and connectors are required to operate the Model 2500INT Integrating Sphere and must be ordered separately. They are not included with the instrument.)

7078-TRX-1	Low-Noise Triax Cable, 0.3m (1 ft)
7078-TRX-3	Low-Noise Triax Cable, 0.9m (3 ft)
7078-TRX-5	Low-Noise Triax Cable, 1.5m (5 ft)
7078-TRX-10	Low-Noise Triax Cable, 3.0m (10 ft)
7078-TRX-12	Low-Noise Triax Cable, 3.5m (12 ft)
7078-TRX-20	Low-Noise Triax Cable, 6.0m (20 ft)
2500INT-FC/APC	FC/APC Connector for 2500INT
2500INT-FC/PC	FC/PC Connector for 2500INT
2500INT-SMA	SMA Connector for 2500INT
6172	2-Slot Male to 3-Lug Female Triax Adapter

### PHOTODIODE SPECIFICATIONS

	Silicon	Germanium	Cooled Indium Gallium Arsenide
Wavelength Range	190–1100nm	800–1800nm	900–1670nm
Peak Sensitivity Wavelength	960nm	1550nm	1550nm
Operating Temperature	-20° to +60°C	-55° to +60°C	-40° to +70°C
Storage Temperature	-55° to +80°C	-55° to +80°C	-55° to +85°C
Active Area	2.4mm × 2.4mm	5.0mm (diameter)	3.0mm (diameter)
Measurement Temperature	—	—	-10°C
Thermistor Allowable Dissipation	—	—	0.2mW
Peltier Element	—	—	1.5A
Allowable Current	—	—	1.0A

# 2510 2510-AT

# TEC SourceMeter® Instrument Autotuning TEC SourceMeter Instrument



The Models 2510 and 2510-AT TEC SourceMeter instruments enhance Keithley's CW (Continuous Wave) test solution for high speed LIV (light-current-voltage) testing of laser diode modules. These 50W bipolar instruments were developed in close cooperation with leading manufacturers of laser diode modules for fiberoptic telecommunications networks. Designed to ensure tight temperature control for the device under test, the Model 2510 was the first in a line of highly specialized instruments created for telecommunications laser diode testing. It brings together Keithley's expertise in high speed DC sourcing and measurement with the ability to control the operation of a laser diode module's Thermo-Electric Cooler or TEC (sometimes called a Peltier device) accurately.

The Model 2510-AT expands the capability of the Model 2510 by offering autotuning capability. P,

I, and D (proportional, integral, and derivative) values for closed loop temperature control are determined by the instrument using a modified Zeigler-Nichols algorithm. This eliminates the need for users to determine the optimal values for these coefficients experimentally. In all other respects, the Model 2510 and Model 2510-AT provide exactly the same set of features and capabilities.

## Ordering Information

<b>2510</b>	<b>TEC SourceMeter</b>
<b>2510-AT</b>	<b>Autotuning TEC SourceMeter Instrument</b>

## Accessories Supplied

**User's Manual, Input/Output Connector**

## The SourceMeter Concept

The Model 2510 and Model 2510-AT draw upon Keithley's unique SourceMeter concept, which combines precision voltage/current sourcing and measurement functions into a single instrument. SourceMeter instruments provide numerous advantages over the use of separate instruments, including lower acquisition and maintenance costs, the need for less rack space, easier system integration and programming, and a broad dynamic range.

## Part of a Comprehensive LIV Test System

In a laser diode CW test stand, the Model 2510 or Model 2510-AT can control the temperature of actively cooled optical components and assemblies (such as laser diode modules) to within  $\pm 0.005^\circ\text{C}$  of the user-defined setpoint. During testing, the instrument measures the internal temperature of the laser diode module from any of a variety of temperature sensors, then drives power through the TEC within the laser diode module in order to maintain its temperature at the desired setpoint.

## ACCESSORIES AVAILABLE

2510-RH	Resistive Heater Adapter for Model 2510
2510-CAB	4-Wire Unshielded Cable, Phoenix Connector to Underminated End
7007-1	Shielded IEEE-488 Cable, 1m (3.3 ft)
7007-2	Shielded IEEE-488 Cable, 2m (6.6 ft)
KPCI-488LPA	IEEE-488 Interface/Controller for the PCI Bus
KUSB-488B	IEEE-488 USB-to-GPIB Adapter for USB Port

## SERVICES AVAILABLE

2510-3Y-EW	1-year factory warranty extended to 3 years from date of shipment
2510-AT-3Y-EW	1-year factory warranty extended to 3 years from date of shipment
C/2510-3Y-DATA	3 (Z540-1 compliant) calibrations within 3 years of purchase for Models 2510, 2510-AT*

\*Not available in all countries

**Figure 1. The capabilities of the Models 2510 and 2510-AT are intended to complement those of other Keithley instruments often used in laser diode module LIV testing, including the Model 2400 and 2420 SourceMeter instruments, the Model 2502 Dual Photo-diode Meter, and the Model 2500INT Integrating Sphere.**

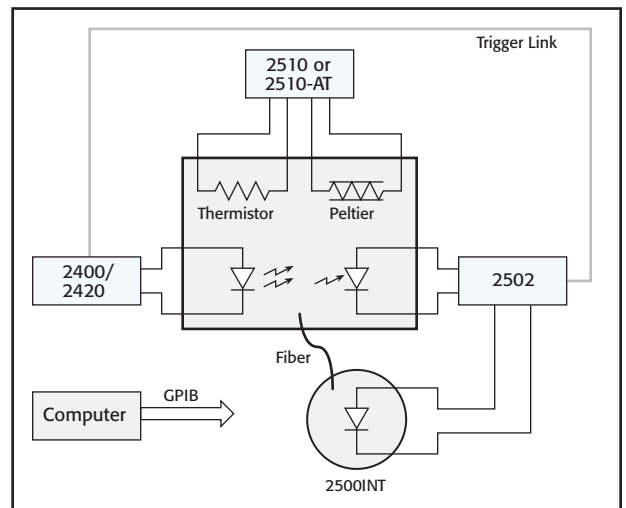

Precision temperature control for TECs with autotuning PID for optimal performance

OPTOELECTRONICS TEST

**1.888.KEITHLEY (U.S. only)**  
**www.keithley.com**

**KEITHLEY**

A GREATER MEASURE OF CONFIDENCE



# 2510 2510-AT

- 50W TEC Controller combined with DC measurement functions
- Fully digital P-I-D control
- Autotuning capability for the thermal control loop (2510-AT)
- Designed to control temperature during laser diode module testing
- Wide temperature setpoint range ( $-50^{\circ}\text{C}$  to  $+225^{\circ}\text{C}$ ) and high setpoint resolution ( $\pm 0.001^{\circ}\text{C}$ ) and stability ( $\pm 0.005^{\circ}\text{C}$ )
- Compatible with a variety of temperature sensor inputs—thermistors, RTDs, and IC sensors
- Maintains constant temperature, current, voltage, and sensor resistance
- AC Ohms measurement function verifies integrity of TEC
- Measures and displays TEC parameters during the control cycle
- 4-wire open/short lead detection for thermal feedback element
- IEEE-488 and RS-232 interfaces
- Compact, half-rack design

## APPLICATIONS

Control and production testing of thermoelectric coolers (Peltier devices) in:

- Laser diode modules
- IR charge-coupled device (CCD) arrays and charge-injection devices (CID)
- Cooled photodetectors
- Thermal-optic switches
- Temperature controlled fixtures

1.888.KEITHLEY (U.S. only)

[www.keithley.com](http://www.keithley.com)

# TEC SourceMeter Instrument Autotuning TEC SourceMeter Instrument

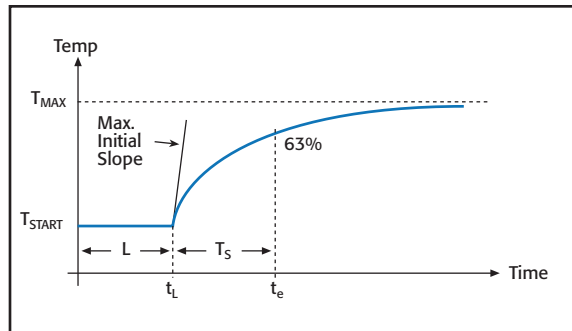

Figure 2.

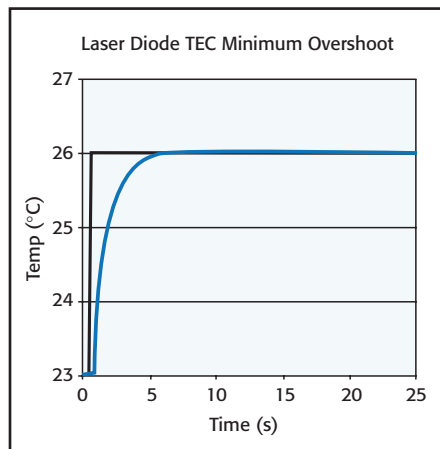

Figure 3.

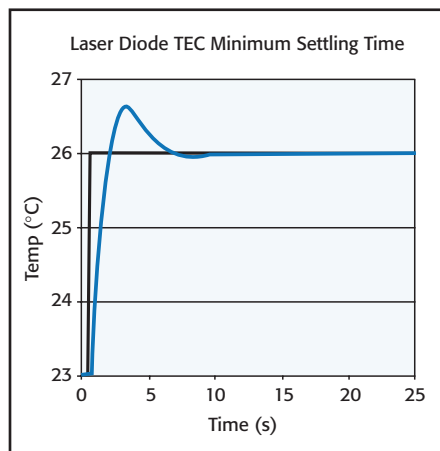

Figure 4.

Active temperature control is very important due to the sensitivity of laser diodes to temperature changes. If the temperature varies, the laser diode's dominant output wavelength may change, leading to signal overlap and crosstalk problems.

## Autotuning Function

The Model 2510-AT Autotuning TEC SourceMeter instrument offers manufacturers the ability to automatically tune the temperature control loop required for CW testing of optoelectronic components such as laser diode modules and thermo-optic switches. This capability eliminates the need for time-consuming experimentation to determine the optimal P-I-D coefficient values.

The Model 2510-AT's P-I-D Auto-Tune software employs a modified Ziegler-Nichols algorithm to determine the coefficients used to control the P-I-D loop. This algorithm ensures that the final settling perturbations are damped by 25% each cycle of the oscillation. The autotuning process begins with applying a voltage step input to the system being tuned (in open loop mode) and measuring several parameters of the system's response to this voltage step function. The system's response to the step function is illustrated in Figure 2. The lag time of the system response, the maximum initial slope, and the TAU [63% (1/e)] response time are measured, then used to generate the Kp (proportional gain constant), Ki (integral gain constant), and Kd (derivative gain constant) coefficients.

The autotuning function offers users a choice of a minimum settling time mode or a minimum overshoot mode, which provides the Model 2510-AT with the flexibility to be used with a variety of load types and devices. For example, when controlling a large area TEC in a test fixture optimized for P, I, and D values, minimum overshoot protects the devices in the fixture from damage (Figure 3). For temperature setpoints that do not approach the maximum specified temperature for the device under test, the minimum settling time mode can be used to speed up the autotuning function (Figure 4).

The autotuning function offers users a choice of a minimum settling time mode or a minimum overshoot mode, which provides the Model 2510-AT with the flexibility to be used with a variety of load types and devices. For example, when controlling a large area TEC in a test fixture optimized for P, I, and D values, minimum overshoot protects the devices in the fixture from damage (Figure 3). For temperature setpoints that do not approach the maximum specified temperature for the device under test, the minimum settling time mode can be used to speed up the autotuning function (Figure 4).

## 50W Output

As the complexity of today's laser diode modules increases, higher power levels are needed in temperature controllers to address the module's cooling needs during production test. The 50W

KEITHLEY

A GREATER MEASURE OF CONFIDENCE

# 2510 2510-AT

# TEC SourceMeter Instrument Autotuning TEC SourceMeter Instrument

(5A @ 10V) output allows for higher testing speeds and a wider temperature setpoint range than other, lower-power solutions.

## High Stability P-I-D Control

When compared with other TEC controllers, which use less sophisticated P-I (proportional-integral) loops and hardware control mechanisms, this instrument's software-based, fully digital P-I-D control provides greater temperature stability and can be easily upgraded with a simple firmware change. The resulting temperature stability ( $\pm 0.005^\circ\text{C}$  short term,  $\pm 0.01^\circ\text{C}$  long term) allows for very fine control over the output wavelength and optical power of the laser diode module during production testing of DC characteristics. This improved stability gives users higher confidence in measured values, especially for components or sub-assemblies in wavelength multiplexed networks. The derivative component of the instrument's P-I-D control also reduces the required waiting time between making measurements at various temperature setpoints. The temperature setpoint range of  $-50^\circ\text{C}$  to  $+225^\circ\text{C}$  covers most of the test requirements for production testing of cooled optical components and sub-assemblies, with a resolution of  $\pm 0.001^\circ\text{C}$ .

Before the introduction of the Model 2510-AT, configuring test systems for new module designs and fixtures required the user to determine the best combination of P, I, and D coefficients through trial-and-error experimentation. The Model 2510-AT's autotuning function uses the modified Zeigler-Nichols algorithm to determine the optimal P, I, and D values automatically.

## Adaptable to Evolving DUT Requirements

The Model 2510 and Model 2510-AT are well suited for testing a wide range of laser diode modules because they are compatible with the types of temperature sensors most commonly used in these modules. In addition to  $100\Omega$ ,  $1\text{k}\Omega$ ,  $10\text{k}\Omega$ , and  $100\text{k}\Omega$  thermistors, they can handle inputs from  $100\Omega$  or  $1\text{k}\Omega$  RTDs, and a variety of solid-state temperature sensors. This input flexibility ensures their adaptability as the modules being tested evolve over time.

## Programmable Setpoints and Limits

Users can assign temperature, current, voltage, and thermistor resistance setpoints. The thermistor resistance setpoint feature allows higher correlation of test results with actual performance in the field for laser diode modules because reference resistors are used to control the temperature of the module. Programmable power, current, and temperature limits offer maximum protection against damage to the device under test.

## Accurate Real-Time Measurements

Both models can perform real-time measurements on the TEC, including TEC current, voltage drop, power dissipation, and resistance, providing valuable information on the operation of the thermal control system.

## Peltier (TEC) Ohms Measurement

TEC devices are easily affected by mechanical damage, such as sheer stress during assembly. The most effective method to test a device for damage after it has been incorporated into a laser diode module is to perform a low-level AC (or reversing DC) ohms measurement. If there is a change in the TEC's resistance value when compared with the manufacturer's specification, mechanical damage is indicated. Unlike a standard DC resistance measurement, where the current passing through the device can produce device heating and affect the measured resistance, the reversing DC ohms method does not and allows more accurate measurements.

## Open/Short Lead Detection

Both models of the instrument use a four-wire measurement method to detect open/short leads on the temperature sensor before testing. Four-wire measurements eliminate lead resistance errors on the measured value, reducing the possibility of false failures or device damage.

## Interface Options

Like all newer Keithley instruments, both models of the instrument include standard IEEE-488 and RS-232 interfaces to speed and simplify system integration and control.

## Optional Resistive Heater Adapter

The Model 2510-RH Resistive Heater Adapter enables either model of the instrument to provide closed loop temperature control for resistive heater elements, rather than for TECs. When the adapter is installed at the instrument's output terminal, current flows through the resistive heater when the P-I-D loop indicates heating. However, no current will flow to the resistive heater when the temperature loop calls for cooling. The resistive element is cooled through radiation, conduction, or convection.

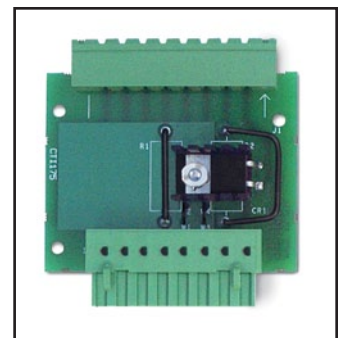

Figure 6. Optional heater adapter

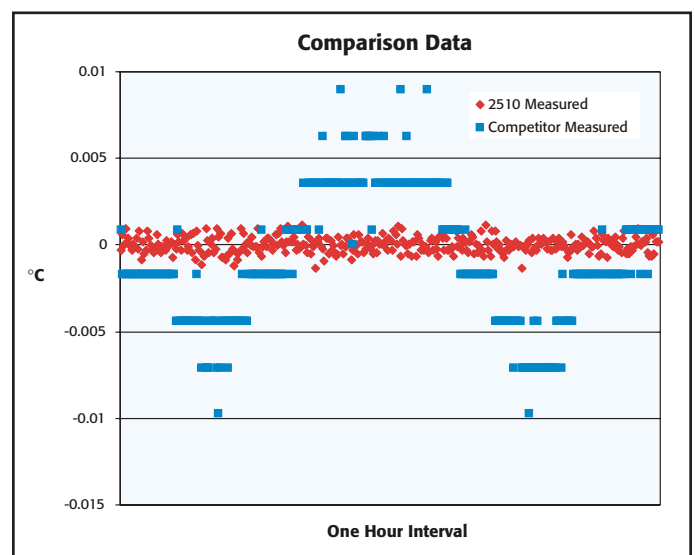

Figure 5. This graph compares the Model 2510/2510-AT's A/D converter resolution and temperature stability with that of a leading competitive instrument. While the competitive instrument uses an analog proportional-integral (P-I) control loop, it displays information in digital format through a low-resolution analog-to-digital converter. In contrast, the Model 2510/2510-AT uses a high-precision digital P-I-D control loop, which provides greater temperature stability, both over the short term ( $\pm 0.005^\circ\text{C}$ ) and the long term ( $\pm 0.01^\circ\text{C}$ ).

1.888.KEITHLEY (U.S. only)

www.keithley.com

KEITHLEY

A GREATER MEASURE OF CONFIDENCE

# 2510 2510-AT

# TEC SourceMeter Instrument Autotuning TEC SourceMeter Instrument

## SPECIFICATIONS

The Models 2510 and 2510-AT TEC SourceMeter instruments are designed to:

- Control the power to the TEC to maintain a constant temperature, current, voltage, or thermistor resistance.
- Measure the resistance of the TEC.
- Provide greater control and flexibility through a software P-I-D loop.

## CONTROL SYSTEM SPECIFICATIONS

SET: Constant Peltier Temperature, Constant Peltier Voltage, Constant Peltier Current. Constant Thermistor Resistance.

CONTROL METHOD: Programmable software PID loop. Proportional, Integral, and Derivative gains independently programmable.

SETPOINT SHORT TERM STABILITY:  $\pm 0.005^\circ\text{C rms}^{1,6,7}$ .

SETPOINT LONG TERM STABILITY:  $\pm 0.01^\circ\text{C}^{1,6,8}$ .

SETPOINT RANGE:  $-50^\circ\text{C}$  to  $225^\circ\text{C}$ .

UPPER TEMPERATURE LIMIT:  $250^\circ\text{C max}$ .

LOWER TEMPERATURE LIMIT:  $-50^\circ\text{C max}$ .

SETPOINT RESOLUTION:  $\pm 0.001^\circ\text{C}$ ,  $< \pm 400\mu\text{V}$ ,  $< \pm 200\mu\text{A}$  0.01% of nominal ( $25^\circ\text{C}$ ) thermistor resistance.

HARDWARE CURRENT LIMIT: 1.0A to 5.25A  $\pm 5\%$ .

SOFTWARE VOLTAGE LIMIT:  $\pm 0.5$  to 10.5V  $\pm 5\%$ .

## THERMAL FEEDBACK ELEMENT SPECIFICATIONS<sup>3</sup>

Sensor Type	RTD		Thermistor				Solid State	
	100 $\Omega$	1 k $\Omega$	100 $\Omega$	1 k $\Omega$	10 k $\Omega$	100 k $\Omega$	Current Output ( $I_{ss}$ )	Voltage Output ( $V_{ss}$ )
Excitation <sup>13</sup>	2.5 mA 4 V max	833 $\mu\text{A}$	2.5 mA 8 V max	833 $\mu\text{A}$ 8 V max	100 $\mu\text{A}$ 8 V max	33 $\mu\text{A}$ 6.6 V max	+13.5 V 833 $\mu\text{A}$	2.5 mA 15.75V max
Nominal Resistance Range	0–250 $\Omega$	0–2.50 k $\Omega$	0–1 k $\Omega$	0–10 k $\Omega$	0–80 k $\Omega$	0–200 k $\Omega$		
Excitation Accuracy <sup>1,3</sup>	$\pm 1.5\%$	$\pm 2.9\%$	$\pm 2.9\%$	$\pm 2.9\%$	$\pm 2.9\%$	$\pm 2.9\%$	$\pm 12\%$	$\pm 2.9\%$
Nominal Sensor Temperature Range	$-50^\circ$ to $+250^\circ\text{C}$	$-50^\circ$ to $+250^\circ\text{C}$	$-50^\circ$ to $+250^\circ\text{C}$	$-50^\circ$ to $+250^\circ\text{C}$	$-50^\circ$ to $+250^\circ\text{C}$	$-50^\circ$ to $+250^\circ\text{C}$	$-40^\circ$ to $+100^\circ\text{C}$	$-40^\circ$ to $+100^\circ\text{C}$
Calibration	$\alpha$ , $\beta$ , $\delta$ settable	$\alpha$ , $\beta$ , $\delta$ settable	A, B, C settable	A, B, C settable	A, B, C settable	A, B, C settable	Slope & offset	Slope & offset
Measurement Accuracy <sup>1,3</sup> $\pm$ (% rdg + offset)	$0.04 + 0.07 \Omega^2$	$0.04 + 0.04 \Omega^2$	$0.04 + 0.07 \Omega^2$	$0.04 + 0.4 \Omega^2$	$0.02 + 3 \Omega$	$0.04 + 21 \Omega$	$0.03 + 100 \text{ nA}$	$0.03 + 500 \mu\text{V}$

## THERMISTOR MEASUREMENT ACCURACY<sup>19</sup>

Nominal Thermistor Resistance	Accuracy vs. Temperature			
	0 $^\circ\text{C}$	25 $^\circ\text{C}$	50 $^\circ\text{C}$	100 $^\circ\text{C}$
100 $\Omega$	0.021 $^\circ\text{C}$	0.035 $^\circ\text{C}$	0.070 $^\circ\text{C}$	0.27 $^\circ\text{C}$
1 k $\Omega$	0.015 $^\circ\text{C}$	0.023 $^\circ\text{C}$	0.045 $^\circ\text{C}$	0.18 $^\circ\text{C}$
10 k $\Omega$	0.006 $^\circ\text{C}$	0.012 $^\circ\text{C}$	0.026 $^\circ\text{C}$	0.15 $^\circ\text{C}$
100 k $\Omega$	0.009 $^\circ\text{C}$	0.014 $^\circ\text{C}$	0.026 $^\circ\text{C}$	0.13 $^\circ\text{C}$

## OPEN/SHORTED ELEMENT DETECTION

SOFTWARE LINEARIZATION FOR THERMISTOR AND RTD

Common Mode Voltage: 30VDC.

Common Mode Isolation:  $>10^9\Omega$ ,  $<1000\text{pF}$ .

Max. Voltage Drop Between Input/Output Sense Terminals: 1V.

Max. Sense Lead Resistance: 100 $\Omega$  for rated accuracy.

Sense Input Impedance:  $>10^8\Omega$ .

## TEC OUTPUT SPECIFICATIONS

OUTPUT RANGE:  $\pm 10\text{VDC}$  at up to  $\pm 5\text{ADC}^{15}$ .

OUTPUT RIPPLE:  $<5\text{mV rms}^9$ .

AC RESISTANCE EXCITATION:  $\pm(9.6\text{mA} \pm 90\mu\text{A})^{14}$ .

## TEC MEASUREMENT SPECIFICATIONS<sup>3</sup>

Function	1 Year, 23 $^\circ\text{C} \pm 5^\circ\text{C}$
Operating Resistance <sup>2, 10, 11, 12</sup>	$\pm(2.0\%$ of rdg + 0.1 $\Omega$ )
Operating Voltage <sup>2,10</sup>	$\pm(0.1\%$ of rdg + 4mV)
Operating Current <sup>10</sup>	$\pm(0.4\%$ of rdg + 8mA)
AC Resistance <sup>2, 18</sup>	$\pm(0.10\%$ of rdg + 0.02 $\Omega$ )

OPEN SHORTED THERMOELECTRIC DETECTION

LOAD IMPEDANCE: Stable into 1 $\mu\text{F}$  typical.

COMMON MODE VOLTAGE: 30VDC maximum.

COMMON MODE ISOLATION:  $>10^9\Omega$ ,  $<1500\text{pF}$ .

MAX. VOLTAGE DROP BETWEEN INPUT/OUTPUT SENSE TERMINALS: 1V.

MAX. SENSE LEAD RESISTANCE: 1 $\Omega$  for rated accuracy.

MAX. FORCE LEAD RESISTANCE: 0.1 $\Omega$ .

SENSE INPUT IMPEDANCE:  $>400\text{k}\Omega$ .

## GENERAL

NOISE REJECTION:

SPEED	NPLC	NMRR <sup>16</sup>	CMRR <sup>17</sup>
Normal	1.00	60 dB	120 dB <sup>1</sup>

SOURCE OUTPUT MODES: Fixed DC level.

PROGRAMMABILITY: IEEE-488 (SCPI-1995.0), RS-232, 3 user-definable power-up states plus factory default and \*RST.

POWER SUPPLY: 90V to 260V rms, 50–60Hz, 75W.

EMC: Complies with European Union Directive 98/336/EEC (CE marking requirements), FCC part 15 class B, CTSPR 11, IEC 801-2, IEC 801-3, IEC 801-4.

VIBRATION: MIL-PRF-28800F Class 3 Random Vibration.

WARM-UP: 1 hour to rated accuracies.

DIMENSIONS, WEIGHT: 89mm high  $\times$  213 mm high  $\times$  370mm deep (3 $\frac{1}{2}$  in  $\times$  8 $\frac{3}{8}$  in  $\times$  14 $\frac{7}{16}$  in). Bench configuration (with handle and feet): 104mm high  $\times$  238mm wide  $\times$  370mm deep (4 $\frac{1}{8}$  in  $\times$  9 $\frac{3}{8}$  in  $\times$  14 $\frac{7}{16}$  in). Net Weight: 3.21kg (7.08 lbs).

ENVIRONMENT: Operating: 0 $^\circ$ –50 $^\circ\text{C}$ , 70% R.H. up to 35 $^\circ\text{C}$ . Derate 3% R.H./ $^\circ\text{C}$ , 35 $^\circ$ –50 $^\circ\text{C}$ . Storage:  $-25^\circ$  to 65 $^\circ\text{C}$ .

## NOTES

1. Model 2510 and device under test in a regulated ambient temperature of 25 $^\circ\text{C}$ .
2. With remote voltage sense.
3. 1 year, 23 $^\circ\text{C} \pm 5^\circ\text{C}$ .
4. With  $I_{load} = 5\text{A}$  and  $V_{load} = 0\text{V}$ .
5. With  $I_{load} = 5\text{A}$  and  $V_{load} = 10\text{V}$ .
6. With 10k $\Omega$  thermistor as sensor.
7. Short term stability is defined as 24 hours with Peltier and Model 2510 at 25 $^\circ\text{C} \pm 0.5^\circ\text{C}$ .
8. Long term stability is defined as 30 days with Peltier and Model 2510 at 25 $^\circ\text{C} \pm 0.5^\circ\text{C}$ .
9. 10Hz to 10MHz measured at 5A output into a 2 $\Omega$  load.
10. Common mode voltage = 0V (meter connect enabled, connects Peltier low output to thermistor measure circuit ground).  $\pm(0.1\%$  of rdg. + 0.1 $\Omega$ ) with meter connect disabled.
11. Resistance range 0 $\Omega$  to 20 $\Omega$  for rated accuracy.
12. Current through Peltier  $> 0.2\text{A}$ .
13. Default values shown, selectable values of 3 $\mu\text{A}$ , 10 $\mu\text{A}$ , 33 $\mu\text{A}$ , 100 $\mu\text{A}$ , 833 $\mu\text{A}$ , 2.5mA. Note that temperature control performance will degrade at lower currents.
14. AC ohms is a dual pulsed measurement using current reversals available over bus only.
15. Settable to  $<400\mu\text{V}$  and  $<200\mu\text{A}$  in constant V and constant I mode respectively.
16. For line frequency  $\pm 0.1\%$ .
17. For 1k $\Omega$  unbalance in LO lead.
18. Resistance range 0 $\Omega$  to 100 $\Omega$  for rated accuracy.
19. Accuracy figures represent the uncertainty that the Model 2510 may add to the temperature measurement, not including thermistor uncertainty. These accuracy figures are for thermistors with typical A,B,C constants.

1.888.KEITHLEY (U.S. only)

www.keithley.com

KEITHLEY

A GREATER MEASURE OF CONFIDENCE

# 8542, 8544, 8544-TEC

- Compatible with Keithley laser diode LIV test solutions
- Simplifies configuration of LIV test systems
- Choice of three fixture designs, all with necessary cables
- Cables also available separately
- Ambient temperature control on TEC version

## Ordering Information

- 8542** Dual In-Line (DIL) Telecom Laser Diode Mount Bundle with 8542-301 and CA-321-1 cables
- 8544** Butterfly Telecom Laser Diode Mount Bundle with 8542-301 and CA-321-1 cables
- 8544-TEC** Butterfly Telecom Laser Diode Mount Bundle with TEC, thermistor, and AD592CN temperature sensor, with 8542-301 and CA-322-1 cables

## Accessories Supplied

- 8542-301** LIV Cable to connect Model 2500 and 24XX to the fixture, 1.8m (6 ft.) (supplied with 8542, 8544, and 8544-TEC)
- CA-321-1** Temp Control Cable to connect Model 2510 to fixture, 1.8m (6 ft.) (supplied with 8542 and 8544)
- CA-322-1** Dual Temp Control Cable to connect (2) Model 2510 to fixture, 1.8m (6 ft.) (supplied with 8544-TEC)

# Laser Diode Mounts for LIV Test Systems

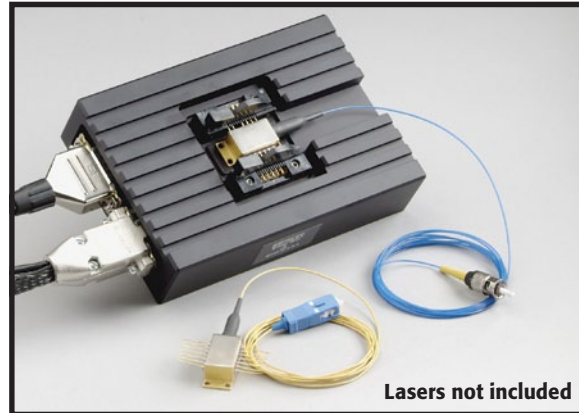

The 854X Laser Diode Mount Series makes it easier than ever to configure a complete laser diode LIV test system for continuous wave test applications. These fixtures provide highly stable temperature control for all telecommunications laser diodes. They offer an easy-to-use platform for testing laser diodes used in telecommunications. They are designed to speed and simplify setting up test systems for all laser diode/photodiode/thermoelectric cooler/thermistor configurations.

Three different fixture bundle designs are available, all of which are compatible with Keithley's popular laser diode LIV test systems. Each bundle includes all cabling required to connect the test instrumentation to the test fixture. Cables are also available separately.

All 14 pin DIL and butterfly laser packages can be mounted on the 854X Series. For higher power butterfly packages without integral thermoelectric coolers (TECs), the Model 8544-TEC offers a TEC and both thermistor and AD592CN sensors.

## APPLICATIONS

- Continuous wave laser diode LIV characterization

## SPECIFICATIONS

This series covers the offering of Laser Diode Mounts (LDM) for use with Continuous LIV Test Solutions. The following products: 2400-LV/2420/2440, 2500/2502, and 2510/2510AT are recommended for use with these products.

### LASER TEMPERATURE CONTROL

TEMPERATURE RANGE: 0° to +80°C.

SENSOR TYPE 2 (Model 8544-TEC Only): 10kΩ thermistor, AD592CN.

### REFERENCED MOUNT SPECIFICATIONS

#### LASER DIODE PACKAGE

Model	8542	8544	8544-TEC
Socket	DIL 14 pin	Butterfly 14 pin	Butterfly 14 pin
Base Plate	Position adjustable	0.1" centers	0.1" centers

### ACCESSORIES AVAILABLE

2400-LV/2420/2440	SourceMeter® Instruments <sup>1</sup>
2502	Dual Photodiode Meter
2510/2510AT	TEC Control Meters (AT: Auto Tune feature)

## GENERAL

### RECOMMENDED MAXIMUM RATINGS<sup>5</sup>:

Drive Current (Amps): 2.

Measured Voltage (Volts): 3.

WEIGHT<sup>6</sup>: 1.0 lbs (0.45kg).

DIMENSIONS<sup>6</sup>: 32mm high × 95mm wide × 140mm deep (1.2in × 3.75 in × 5.5 in).

## NOTES

1. The other SourceMeter offerings from Keithley, Models 2400, 2410, 2425, and 2430, are not recommended for use with the 8542-301 and Laser Diode Mounts unless proper interlock and safety precautions are observed (especially voltage protection).
2. The 8544-TEC unit is shipped with the 10kΩ thermistor wired. This is the more commonly requested configuration. The AD592CN sensor wires are available but not connected.
3. The triax inner shield is available on pin 2 of the 8542-301A. This will allow flexibility for the customer to exchange the wire in the LDM from pin 6 to pin 2.
4. To use the second 2510 (DB-15 pins 9–15), the customer must internally wire the 8544-TEC Mount to the DUT thermocouple. See the Quick Start Guide for wiring configuration.
5. Ratings are based on use of mount with provided cables and average majority of laser diode characteristics.
6. The weight and dimension is the mounting unit without the cables.

1.888.KEITHLEY (U.S. only)

www.keithley.com

KEITHLEY

A GREATER MEASURE OF CONFIDENCE

**7090**

# Optical Switch Cards

Use with 7001 and 7002 scanner mainframes.

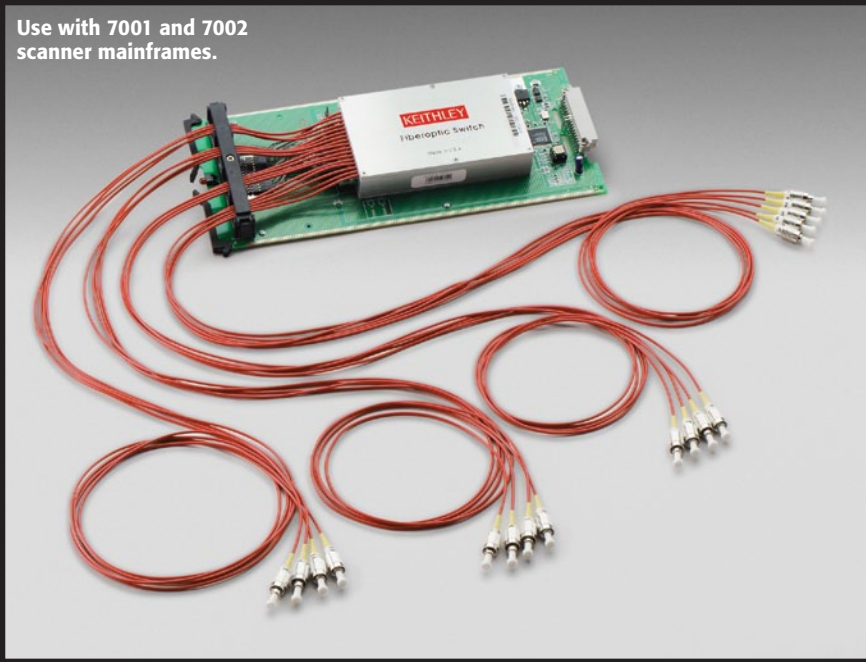

- Perform multiple tests on a single device without changing test setup
- Test multiple devices with a single instrument
- 1×8 and 1×16 optical switching cards
- Single-mode or multimode fiber
- Very low insertion loss, 0.6dB typ.
- 0.03dB repeatability
- FC/SPC connectors
- Bulkhead options available

the test setup. Each switch card has one input fiber aligned to one of eight or sixteen output fibers. Depending on the card chosen, the fiber is either a 9 $\mu$ m single-mode fiber or 62.5 $\mu$ m multimode fiber. The input and output fiber channels are available with several connection options, including FC/SPC and a one-meter fiber pigtail with a connector. For a complete list of available features, see the Physical Properties table on the following page.

### Seamless Integration with Keithley's LIV Test Solution

The Model 7090 cards are designed to allow tight integration with Keithley's LIV Test System. The LIV Test System combines all of the DC measurement capabilities required to test laser diode modules, including optical power measurement and tight temperature control of the device under test, in an integrated instrument package. The high speed Trigger Link interface provided on the instruments and switch mainframe in the LIV Test System allows for tight synchronization of system functions.

### Faster Test Development

Several built-in features of the Models 7001 and 7002 mainframes simplify system setup, operation, and modifications. All aspects of the instrument can be programmed from either the mainframe's front panel or over the IEEE bus. Both mainframes offer Trigger Link interfaces to ensure tight control over the test system and eliminate IEEE bus command overhead.

The Model 7090 Optical Switch Cards are members of Keithley's family of switch cards designed for the Models 7001 and 7002 Switch Mainframes. These cards simplify making accurate connections from one input fiber channel to either eight or sixteen output fiber channels. When combined with existing Series 7001/7002 switch cards, these optical switches allow for hybrid switching combinations of optical, RF, and DC switching within a single switch mainframe, extending the automated testing environment.

### Combine Optical, DC, and RF Switching in One Instrument

The Model 7090 cards are compatible with all other Series 7001/7002 switch cards, so they can be used in conjunction with DC switch cards to control an LIV test system, as well as for RF switching needs. All of the switches can be used in one mainframe with a single GPIB address.

### Meets a Range of Test Requirements

Model 7090 cards offer a number of options to ensure the compatibility of the switch with

### APPLICATIONS

#### Production testing of:

- Laser diode modules
- Chip on submount laser diodes
- Laser diode bars
- LEDs and OLEDs
- Passive optical components
- VCSEL arrays
- Optical add/drop multiplexer (OADM)

1.888.KEITHLEY (U.S. only)

[www.keithley.com](http://www.keithley.com)

**KEITHLEY**

A GREATER MEASURE OF CONFIDENCE

# 7090

## Ordering Information

**7090-8-4 1×8 Multimode with FC/SPC Fiber Pigtail**

**7090-16-6 1×16 Single-Mode with FC/SPC Fiber Pigtail**

**Accessories Supplied**

**User's Manual**

## RELATED DC/RF SWITCH OPTIONS

7011-C	Quad 1×10 Multiplexer Card
7012-C	4×10 Matrix Card
7053	High Current Switch Card
7016A	2GHz, Dual 1×4, 50Ω Card
7017	800MHz Card
7038	2GHz, 75Ω Card

## SERVICES AVAILABLE

7090-16-6-3Y-EW	1-year factory warranty extended to 3 years from date of shipment
7090-8-4-3Y-EW	1-year factory warranty extended to 3 years from date of shipment

# Optical Switch Cards

## PHYSICAL PROPERTIES

CONFIGURATION: Single channel, 1×N non-blocking switch.

Model Number	No. of Channels	Fiber Type	Wavelength (nm)	Connector	Fiber Length
7090-8-4	1×8	Multimode fiber 62.5/125 each ch.	780-1350	FC/SPC	1m
7090-16-6	1×16	Single-mode fiber (SMF-28) 9/125 each ch.	1290-1650	FC/SPC	1m

## REFERENCED SWITCH MANUFACTURER'S OPTICAL SPECIFICATIONS <sup>1</sup>

	Typical	Maximum	Units
Wavelength Range	780 to 1650		nm
Switch Life	> 10 million cycles (min.)		
Insertion Loss <sup>2</sup>	0.6	1.2	dB
Repeatability <sup>3</sup>	—	±0.03	dB
Back Reflection (SM/MM) <sup>4</sup>	-60 / -20	-55 / —	dB
Polarization Dependent Loss (PDL) <sup>5</sup>	—	0.05	dB
Crosstalk	—	-80	dB

## GENERAL

<b>SWITCHING TIME<sup>6</sup>:</b>	<b>1×8</b>	<b>1×16</b>
Reset/Open	315ms	450ms
Settle/Close	500ms	630ms

**DIMENSIONS, WEIGHT:** 144mm wide × 272mm high × 32mm deep (4.5 in × 10.75 in × 1.25 in). Net weight 0.66kg (1.5 lb).

**ENVIRONMENT: Operating Temperature:** 0° to 40°C<sup>7</sup>. **Storage Temperature:** -20° to 65°C. **Relative Humidity:** Up to 35°C <80% RH non-condensing.

**EMC:** European Union Directive 89/336/EEC EN61326.

**SAFETY:** European Union Directive 73/23/EEC EN61010-1.

## NOTES

- All optical specifications are referenced without connectors and are guaranteed by switch manufacturer only. Connectorization data will be provided for Insertion Loss and Back Reflection for each channel per switch card.
- Measured at 23° ± 5°C.
- Sequential repeatability for 100 cycles at constant temperature after warm up. (Difference in Insertion Loss).
- Based on standard 1m pigtail length.
- Measured at 1550nm.
- Actuation time measured from system trigger. Reset/Open refers to Channel N to Reset time. Settle/Close refers to Reset to Channel N or Channel N to Channel M time. Reset position is optically blocked.
- At higher operating temperatures, a typical additive insertion loss of 0.1dB should be expected for the strain relief model (0.3dB for the bulkhead model).

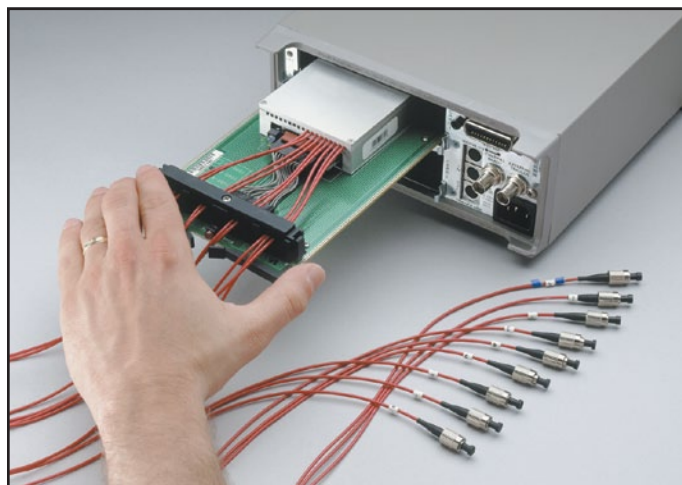

**1.888.KEITHLEY (U.S. only)**

**www.keithley.com**

**KEITHLEY**

A GREATER MEASURE OF CONFIDENCE

**1.888.KEITHLEY** (U.S. only)

**[www.keithley.com](http://www.keithley.com)**

**KEITHLEY**

A GREATER MEASURE OF CONFIDENCE